

YAMAHA

RX-V2092

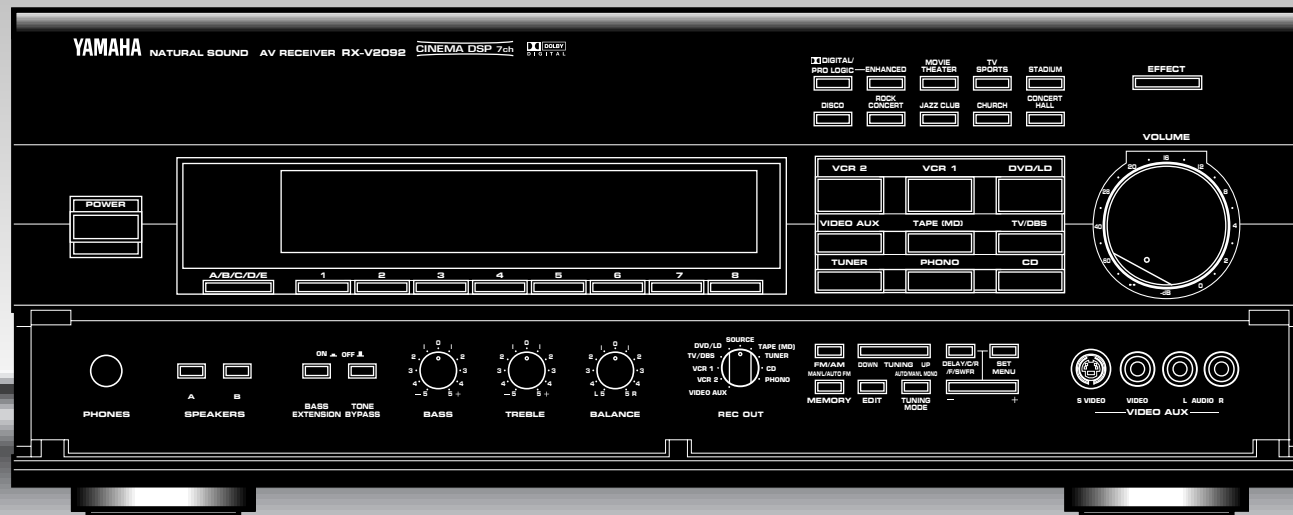

Natural Sound AV Receiver
Récepteur audiovisuel "Son Naturel"

OWNER'S MANUAL
MODE D'EMPLOI

SAFETY INSTRUCTIONS

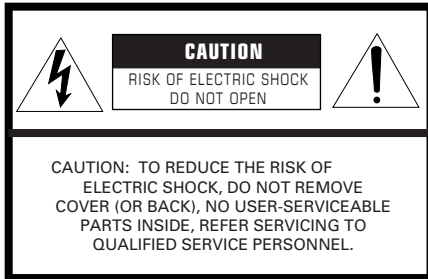

• Explanation of Graphical Symbols



The lightning flash with arrowhead symbol, within an equilateral triangle, is intended to alert you to the presence of uninsulated "dangerous voltage" within the product's enclosure that may be of sufficient magnitude to constitute a risk of electric shock to persons.



The exclamation point within an equilateral triangle is intended to alert you to the presence of important operating and maintenance (servicing) instructions in the literature accompanying the appliance.

WARNING

TO REDUCE THE RISK OF FIRE OR ELECTRIC SHOCK, DO NOT EXPOSE THIS UNIT TO RAIN OR MOISTURE.

1 Read Instructions – All the safety and operating instructions should be read before the unit is operated.

2 Retain Instructions – The safety and operating instructions should be retained for future reference.

3 Heed Warnings – All warnings on the unit and in the operating instructions should be adhered to.

4 Follow Instructions – All operating and other instructions should be followed.

5 Water and Moisture – The unit should not be used near water – for example, near a bathtub, washbowl, kitchen sink, laundry tub, in a wet basement, or near a swimming pool, etc.

6 Carts and Stands – The unit should be used only with a cart or stand that is recommended by the manufacturer.

6A A unit and cart combination should be moved with care. Quick stops, excessive force, and uneven surfaces may cause the unit and cart combination to overturn.



7 Wall or Ceiling Mounting – The unit should be mounted to a wall or ceiling only as recommended by the manufacturer.

8 Ventilation – The unit should be situated so that its location or position does not interfere with its proper ventilation. For example, the unit should not be situated on a bed, sofa, rug, or similar surface, that may block the ventilation openings; or placed in a built-in installation, such as a bookcase or cabinet that may impede the flow of air through the ventilation openings.

9 Heat – The unit should be situated away from heat sources such as radiators, stoves, or other appliances that produce heat.

10 Power Sources – The unit should be connected to a power supply only of the type described in the operating instructions or as marked on the unit.

11 Power-Cord Protection – Power-supply cords should be routed so that they are not likely to be walked on or pinched by items placed upon or against them, paying particular attention to cords at plugs, convenience receptacles, and the point where they exit from the unit.

12 Cleaning – The unit should be cleaned only as recommended by the manufacturer.

13 Nonuse Periods – The power cord of the unit should be unplugged from the outlet when left unused for a long period of time.

14 Object and Liquid Entry – Care should be taken so that objects do not fall into and liquids are not spilled into the inside of the unit.

15 Damage Requiring Service – The unit should be serviced by qualified service personnel when:

- A. The power-supply cord or the plug has been damaged;
- or
- B. Objects have fallen, or liquid has been spilled into the unit;
- or
- C. The unit has been exposed to rain;
- or
- D. The unit does not appear to operate normally or exhibits a marked change in performance;
- or
- E. The unit has been dropped, or the cabinet damaged.

16 Servicing – The user should not attempt to service the unit beyond those means described in the operating instructions. All other servicing should be referred to qualified service personnel.

17 Power Lines – An outdoor antenna should be located away from power lines.

18 Grounding or Polarization – Precautions should be taken so that the grounding or polarization is not defeated.

19 For US customers only:

Outdoor Antenna Grounding – If an outside antenna is connected to this unit, be sure the antenna system is grounded so as to provide some protection against voltage surges and built-up static charges. Article 810 of the National Electrical Code, ANSI/NFPA 70, provides information with regard to proper grounding of the mast and supporting structure, grounding of the lead-in wire to an antenna discharge unit, size of grounding conductors, location of antenna discharge unit, connection to grounding electrodes, and requirements for the grounding electrode.

Note to CATV system installer:

This reminder is provided to call the CATV system installer's attention to Article 820-40 of the NEC that provides guidelines for proper grounding and, in particular, specifies that the cable ground shall be connected to the grounding system of the building, as close to the point of cable entry as practical.

EXAMPLE OF ANTENNA GROUNDING

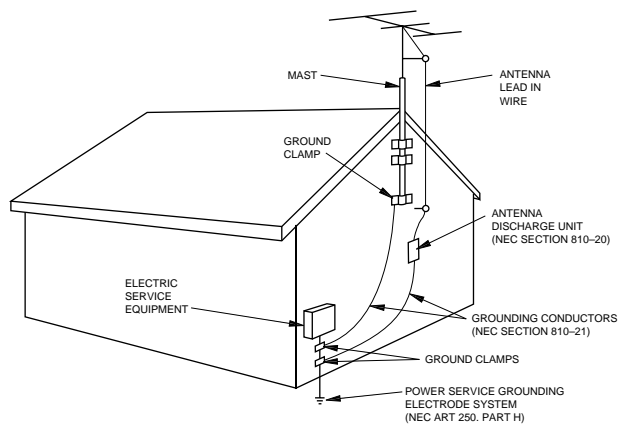

NEC – NATIONAL ELECTRICAL CODE

**We Want You Listening For A Lifetime
(for US customers only)**

YAMAHA and the Electronic Industries Association's Consumer Electronics Group want you to get the most out of your equipment by playing it at a safe level. One that lets the sound come through loud and clear without annoying blaring or distortion – and, most importantly, without affecting your sensitive hearing. Since hearing damage from loud sounds is often undetectable until it is too late, YAMAHA and the Electronic Industries Association's Consumer Electronics Group recommend you to avoid prolonged exposure from excessive volume levels.



SPECIAL NOTES FOR FCC COMPOSITE DEVICE (for US customers only)

This device is a composite system. The digital device component may not cause harmful interference.

FCC INFORMATION (for US customers only)

1. IMPORTANT NOTICE : DO NOT MODIFY THIS UNIT!

This product, when installed as indicated in the instructions contained in this manual, meets FCC requirements. Modifications not expressly approved by Yamaha may void your authority, granted by the FCC, to use the product.

2. IMPORTANT : When connecting this product to accessories and/or another product use only high quality shielded cables. Cable/s supplied with this product MUST be used. Follow all installation instructions. Failure to follow instructions could void your FCC authorization to use this product in the USA.

3. NOTE : This product has been tested and found to comply with the requirements listed in FCC Regulations, Part 15 for Class "B" digital devices. Compliance with these requirements provides a reasonable level of assurance that your use of this product in a residential environment will not result in harmful interference with other electronic devices.

This equipment generates/uses radio frequencies and, if not installed and used according to the instructions found in the users manual, may cause interference harmful to the operation of other electronic devices.

Compliance with FCC regulations does not guarantee that interference will not occur in all installations. If this product is found to be the source of interference, which can be determined by turning the unit "OFF" and "ON", please try to eliminate the problem by using one of the following measures:

Relocate either this product or the device that is being affected by the interference.

Utilize power outlets that are on different branch (circuit breaker or fuse) circuits or install AC line filter/s.

In the case of radio or TV interference, relocate/reorient the antenna. If the antenna lead-in is 300 ohm ribbon lead, change the lead-in to coaxial type cable.

If these corrective measures do not produce satisfactory results, please contact the local retailer authorized to distribute this type of product. If you can not locate the appropriate retailer, please contact Yamaha Electronics Corp., U.S.A. 6660 Orangethorpe Ave, Buena Park, CA 90620.

The above statements apply ONLY to those products distributed by Yamaha Corporation of America or its subsidiaries.

Congratulations!

You are the proud owner of a Yamaha Digital Sound Field Processing (DSP) System—an extremely sophisticated audio component. The DSP system takes full advantage of Yamaha's undisputed leadership in the field of digital audio processing to bring you a whole new world of listening experiences. Follow the instructions in this manual carefully when setting up your system, and the DSP system will sonically transform your room into a wide range of listening environments—anything from a famous concert hall to a cozy jazz club. In addition, you get incredible realism from Dolby-Surround encoded video sources using the built-in Dolby Pro Logic Surround Decoder and Dolby Digital (AC-3) Decoder.

Seven built-in channels of amplification on this model mean that no additional amplifiers are required to enjoy advanced digital sound field processing.

Rather than tell you about the wonders of digital sound field processing, however, let's get right down to the business of setting up the system and trying out its many capabilities. Please read this operation manual carefully and store it in a safe place for later reference.

PRECAUTIONS

1. PLEASE READ THIS MANUAL CAREFULLY

To assure the finest performance, please read this manual carefully. Keep it in a safe place for future reference.

2. AVOID EXCESSIVE HEAT, HUMIDITY, DUST AND VIBRATION

Keep the unit away from locations where it is likely to be exposed to high temperatures or humidity—such as near radiators, stoves, etc. Also avoid locations which are subject to excessive dust accumulation or vibration which could cause mechanical damage.

3. INSTALL THE UNIT IN WELL-VENTILATED CONDITION

The openings on the cabinet assure proper ventilation of the unit. If these openings are obstructed, the temperature inside the cabinet will rise rapidly. Therefore, avoid placing objects against these openings, and install the unit in well-ventilated condition. Make sure to allow a space of at least 10 cm behind, 20 cm on the both sides and 30 cm above the top panel of the unit. Otherwise it may not only damage the unit, but also cause fire.

4. KEEP THE AC POWER PLUG DISCONNECTED DURING VACATION ETC.

When not planning to use this unit for long periods of time (ie., vacation, etc.), disconnect the AC power plug from the wall outlet.

5. AVOID PHYSICAL SHOCKS

Strong physical shocks to the unit can cause damage. Handle it with care.

6. DO NOT OPEN THE UNIT OR ATTEMPT REPAIRS OR MODIFICATIONS YOURSELF

This product contains no user-serviceable parts. Refer all maintenance to qualified Yamaha service personnel. Opening the unit and/or tampering with the internal circuitry will make servicing difficult and will endanger you and your unit.

7. MAKE SURE POWER IS OFF BEFORE MAKING OR REMOVING CONNECTIONS

Always turn power OFF prior to connecting or disconnecting cables. This is important to prevent damage to the unit itself as well as other connected equipment.

8. USE THIS UNIT PROPERLY

Do not use force on switches, controls or connection wires. When moving the unit, first disconnect the power plug and the wires connected to other equipment. Never pull the wires themselves.

9. TAKE CARE OF THE VOLUME CONTROL SETTING

Always set the VOLUME control to “- ∞” before starting the audio source play. Increase the volume gradually to an appropriate level after playback has been started.

10. HANDLE CABLES CAREFULLY

Always plug and unplug cables—including the AC cord—by gripping the connector, not the cord.

11. PREVENT LIGHTNING DAMAGE

To prevent lightning damage, disconnect the AC power plug and disconnect the antenna cable when there is an electrical storm.

12. CLEAN WITH A SOFT DRY CLOTH

Never use solvents such as benzine or thinner to clean the unit. Wipe clean with a soft, dry cloth.

13. USE THIS UNIT WITH THE CORRECT VOLTAGE

The voltage to be used must be the same as that specified on this unit. Using this unit with a higher voltage than that which is specified is dangerous and may result in a fire or other type of accident causing damage. YAMAHA will not be held responsible for any damage resulting from use of this unit with a voltage other than that which is specified.

IMPORTANT!

Please record the model and serial number of your unit in the space below.

Model:

Serial No.:

The serial number is located on the rear of the unit. Retain this Owner's Manual in a safe place for future reference.

Voltage Selector (General Model only)

The voltage selector on the rear panel of this unit must be set for your local mains voltage BEFORE plugging into the AC mains supply. Voltages are 110/120/220/240 AC, 50/60 Hz.

WARNING

To reduce the risk of fire or electric shock, do not expose this unit to rain or moisture.

CAUTION (FOR CANADA MODEL)

TO PREVENT ELECTRIC SHOCK, MATCH WIDE BLADE OF PLUG TO WIDE SLOT AND FULLY INSERT.

FOR CANADIAN CUSTOMER

THIS CLASS B DIGITAL APPARATUS MEETS ALL REQUIREMENTS OF THE CANADIAN INTERFERENCE-CAUSING EQUIPMENT REGULATIONS.

The apparatus is not disconnected from the AC power source as long as it is connected to the wall outlet, even if the apparatus itself is turned off.

WARNING

Do not change the IMPEDANCE SELECTOR switch setting while the power to this unit is on, otherwise this unit may be damaged.

IF THIS UNIT FAILS TO TURN ON WHEN THE POWER SWITCH IS PRESSED

The IMPEDANCE SELECTOR switch may not be set to either end closely. If so, set the switch to either end closely.

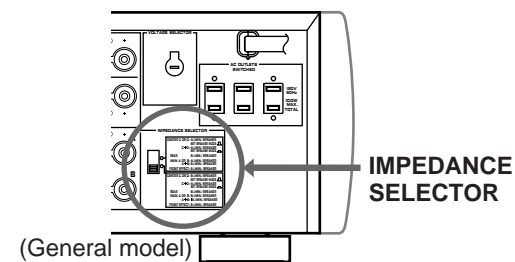

CONTENTS

SAFETY INSTRUCTIONS	Inside the cover	TUNING OPERATIONS	50
PRECAUTIONS	1	AUTOMATIC TUNING.....	50
GETTING STARTED	3	MANUAL TUNING.....	50
FEATURES	5	PRESET TUNING	51
SPEAKER SETUP	10	MANUAL PRESET TUNING.....	51
CONTROLS & THEIR FUNCTIONS	13	AUTOMATIC PRESET TUNING.....	52
FRONT PANEL.....	13	EXCHANGING PRESET STATIONS.....	53
DISPLAY PANEL.....	16	SELECTING SOUND FIELD PROGRAMS	54
CONNECTIONS	18	CANCELING THE EFFECT SOUND.....	55
REAR PANEL PARTS AND THEIR FUNCTIONS.....	18	DESCRIPTIONS OF THE SOUND FIELD PROGRAMS.....	56
REAR PANEL SWITCH AND CONTROL SETTINGS.....	22	ADJUSTING DELAY TIME AND EACH SPEAKER OUTPUT LEVEL.....	59
GENERAL INSTRUCTIONS FOR CONNECTIONS.....	22	SETTING THE SLEEP TIMER	61
CONNECTING AUDIO/VIDEO SOURCE EQUIPMENT TO THIS UNIT.....	23	REMOTE CONTROL UNIT	62
ANTENNA CONNECTIONS.....	27	BASIC OPERATIONS (When the lid is open).....	62
CONNECTING SPEAKER SYSTEMS.....	30	LEARNING NEW CONTROL FUNCTIONS (When the lid is open)	64
SELECTING THE OUTPUT MODES SUITABLE FOR YOUR SPEAKER SYSTEM.....	35	USING OPERATION CONTROL KEYS (When the lid is closed)	67
CONNECTING AND CONTROLLING ROOM 2 EQUIPMENT	38	MACRO OPERATIONS (When the lid is closed).....	70
CONNECTIONS.....	38	LEARNING A NEW FUNCTION.....	73
ROOM 2 REMOTE CONTROL UNIT.....	39	MAKING A NEW MACRO.....	75
SPEAKER BALANCE ADJUSTMENT	41	CLEARING LEARNED FUNCTIONS.....	76
ADJUSTMENTS IN THE “SET MENU” MODE	43	TROUBLESHOOTING	78
GENERAL OPERATION	46	SPECIFICATIONS	81
PLAYING A SOURCE.....	46		
RECORDING A SOURCE TO AUDIO/VIDEO TAPE (OR DUBBING FROM A TAPE TO ANOTHER).....	48		

GETTING STARTED

Unpacking

If you haven't already done so, carefully remove this unit and its accessories from the box and wrapping material. You should find the unit itself and the following accessories.

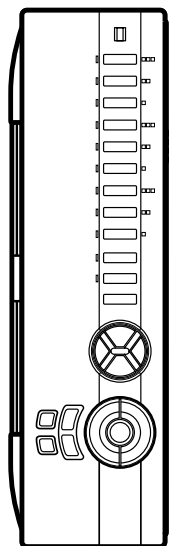

Remote control (for the main room)

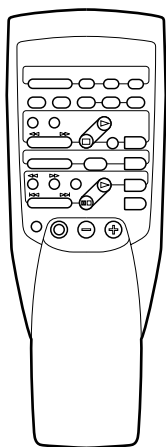

Room 2 remote control unit

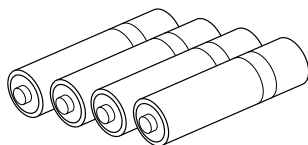

Batteries

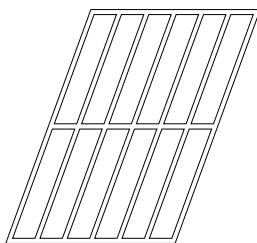

User function stickers

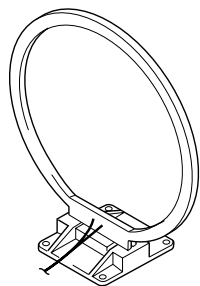

AM loop antenna

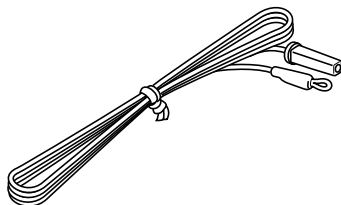

Indoor FM antenna

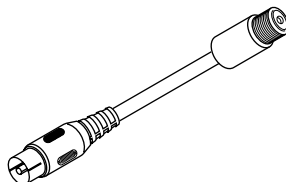

Antenna adapter
(U.S.A. and Canada models only)

Installing the Remote Control Unit Batteries

Since the remote control unit will be used for many of this unit's control operations, you should begin by installing the supplied batteries.

1. Turn the remote control unit over and slide the battery compartment cover downward in the direction of the arrow.
2. Insert the batteries (LR6, AA, UM-3 type), being careful to align them with the polarity markings on the inside of the battery compartment.
3. Close the battery compartment cover.

Remote control unit (for the main room)

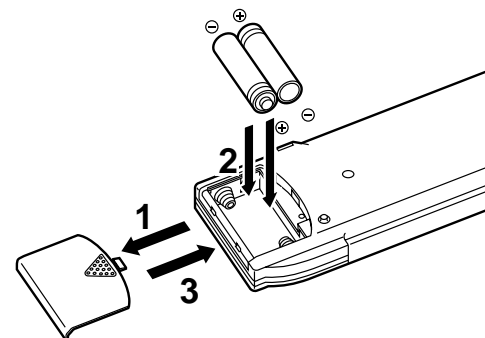

Room 2 remote control unit

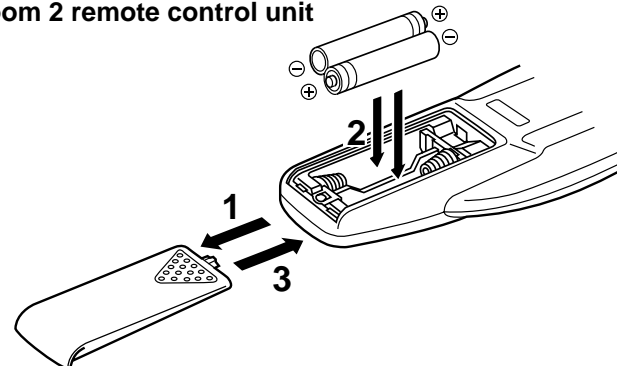

- * **For the remote control unit for the main room only**
After you insert batteries (or you exchange batteries with new ones), press the RESET button before using the remote control unit.

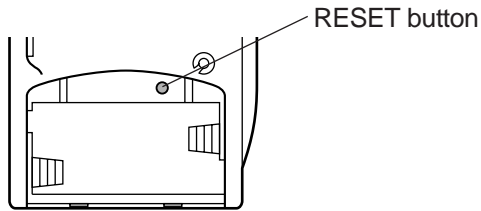

Remote control transmitter operation range

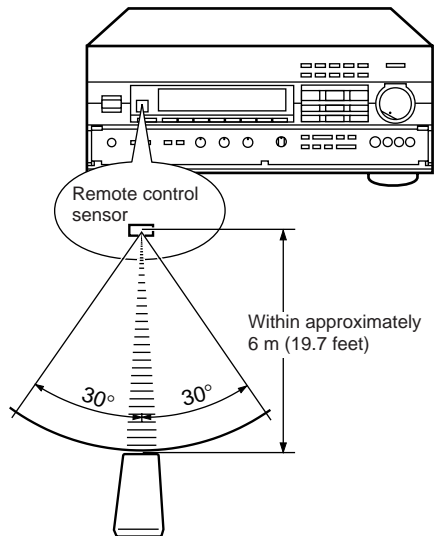

Notes

- There should be no large obstacles between the remote control unit and the main unit.
- If the remote control sensor is directly illuminated by strong lighting (especially an inverter type of fluorescent lamp etc.), it might cause the remote control unit to work incorrectly. In this case, reposition the main unit to avoid direct lighting.

Notes about the Remote Control Unit

- When you notice that remote control operation has become erratic, or the distance from which the remote control will function has decreased, it's time to replace the batteries. Always replace all batteries at the same time.
- This remote control uses an advanced, highly directional infrared beam. Be sure to aim the remote control directly at the remote control sensor on the main unit when operating.

Open/close the control door

When it is not necessary to operate controls inside the control door, close the door.

To open the door

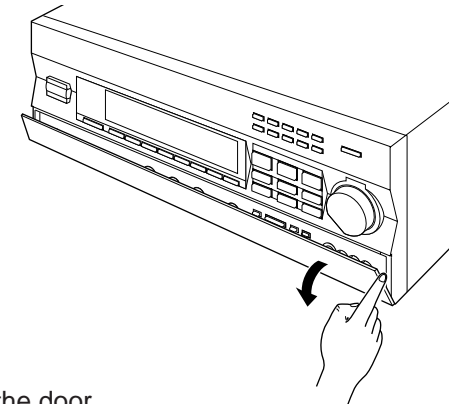

To close the door

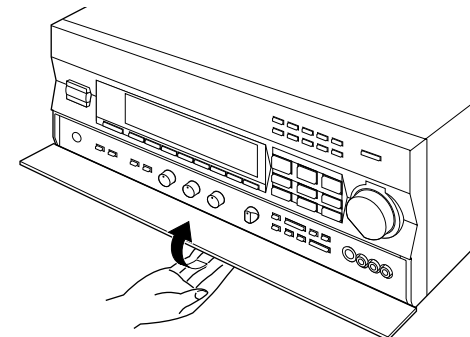

FEATURES

This unit incorporates a sophisticated, multi-program digital sound field processor. The processor allows you to electronically expand and change the shape of the audio sound field from both audio and video sources, creating a theater-like experience in your listening room. This unit has a total of 10 digital sound field processor (DSP) modes. You can create an excellent audio sound field by selecting a suitable sound field (this will, of course, depend on what you will be listening to), and adding desired adjustments.

In addition, this unit incorporates a Dolby Pro Logic Surround decoder and Dolby Digital (AC-3) decoder for multi-channel sound reproduction of Dolby Surround encoded video sources. The operation of the Dolby Pro Logic Surround or Dolby Digital (AC-3) decoder can be controlled by selecting a corresponding DSP program including combined operations of the Yamaha DSP and the Dolby Pro Logic Surround or Dolby Digital (AC-3) decoder.

Digital Sound Field Processing

What is it that makes live music so good? Today's advanced sound reproduction technology lets you get extremely close to the sound of a live performance, but chances are you'll still notice something missing, the acoustic environment of the live concert hall. Extensive research into the exact nature of the sonic reflections that create the ambience of a large hall has made it possible for Yamaha engineers to bring you this same sound in your own listening room, so you'll feel all the sound of a live concert. What's more, our technicians, armed with sophisticated measuring equipment, have even made it possible to capture the acoustics of a variety of actual concert halls, jazz clubs, theaters, etc. from around the world, to allow you to accurately recreate any one of these live performance environments, all in your own home.

Dolby Pro Logic Surround

This unit employs a Dolby Pro Logic Surround decoder similar to professional Dolby Stereo decoders used in many movie theaters. By using the Dolby Pro Logic Surround decoder, you can experience the dramatic realism and impact of Dolby Surround movie theater sound in your own home. Dolby Pro Logic employs a four channel five speaker system. The Pro Logic Surround system divides the input signal into four levels: the left and right main channels, the center channel (used for dialog), and the rear surround sound channels (used for sound effects, background noise, and other ambient noises). The center channel allows listeners seated in even less-than-ideal positions to hear the dialog originating from the action on the screen while experiencing good stereo imaging. Dolby Surround is encoded on the sound track of pre-recorded video tapes, laser discs, and some TV/cable broadcasts. When you play a source encoded with Dolby Surround on this unit, the Dolby Pro Logic Surround decoder decodes the signal and distributes the surround-sound effects.

This Dolby Pro Logic Surround Decoder employs a digital signal processing system. This system improves the stability of sound at each channel and crosstalk between channels, so that positioning of sounds around the room is more accurate compared with conventional analog signal processing systems.

In addition, this unit features a built-in automatic input balance control. This always assures you the best performance without manual adjustment.

Dolby Digital (AC-3)

The built-in Dolby Digital (AC-3) Decoder leads you into a totally new sound experiences.

Dolby Digital (AC-3) is a new generation of multi-channel digital audio technology, or the newest spatial sound processing format developed for 35 mm film-movies by employing a new kind of low bit-rate audio coding.

Dolby Digital (AC-3) is a digital surround sound system that provides completely independent multi-channel audio to consumers. In multi-channel form, Dolby Digital (AC-3) provides five full range channels in what is sometimes referred to as a "3/2" configuration: three front channels (left, center and right), plus two surround channels. A sixth bass-only effect channel is also provided for output of LFE (low frequency effect), or low bass effects that are independent of other channels. This channel is counted as 0.1, thus giving rise to the term 5.1 channels in total.

Compared to Dolby Pro Logic that is referred to a "3/1" system (left front, center, right front and just one surround channel), Dolby Digital (AC-3) features two surround channels, called stereo or split surrounds, each offering the same full range fidelity as the three front channels.

Sound of wide dynamic range reproduced by the five full range channels presents listeners much excitement that has never been experienced before. Precise sound orientation by the discrete digital sound processing expands realism that the original movie possesses.

Laser Disc is a home audio format that could benefit from Dolby Digital (AC-3). In the near future, Dolby Digital (AC-3) will also be applied to DBS, CATV, DVD and HDTV. The ongoing release of Dolby Stereo Digital theatrical films now underway will provide an immediate source of Dolby Digital (AC-3) encoded video software.



Manufactured under license from Dolby Laboratories Licensing Corporation. "Dolby", "AC-3", "Pro Logic", and the double-D symbol are trademarks of Dolby Laboratories Licensing Corporation. Copyright 1992 Dolby Laboratories, Inc. All rights reserved.

The following original functions make the surround-sound effect of Dolby Digital (AC-3) become the most suitable for your audio system and the listening conditions.

- **Dynamic range (sound scale) of source can be changed so that it will be suitable for the listening conditions.**
- **Output of low bass from any channel can be assigned to either the MAIN SPEAKERS terminals or SUBWOOFER terminals to maximize system performance.**
- **Output of LFE can be assigned to either the MAIN SPEAKERS terminals or SUBWOOFER terminals to maximize system performance.**

Dolby Surround + DSP (CINEMA DSP)

Dolby Surround sound system shows its full ability in a large movie theater, because movie sounds are originally designed to be reproduced in a large movie theater using many speakers. It is difficult to create a sound environment similar to that of a movie theater in your listening room, because the room size, materials of inside walls, the number of speakers, etc. of your listening room is much different from those of a movie theater.

Yamaha DSP technology made it possible to present you with nearly the same sound experience as that of a large movie theater in your listening room by compensating for lack of presence and dynamics in your listening room with its original digital sound fields combined with Dolby Surround sound field.

CINEMA DSP 7ch

The YAMAHA "CINEMA DSP" logo indicates those programs are created by the combination of Dolby Surround and YAMAHA DSP technology.

Dolby Pro Logic + 2 Digital Sound Fields

Digital sound fields are created on the presence side and the rear surround side of the Dolby Pro Logic Surround-decoded sound field respectively. They create a wide acoustic environment and emphasize surround-effect in the room, letting you feel much presence as if you are watching a movie in a popular Dolby Stereo theater.

This combination is available when the sound field program No. 2, No. 3 or No. 4 is selected, and the input signal of source is analog, PCM audio or encoded with the Dolby Digital (AC-3) in 2-channels.

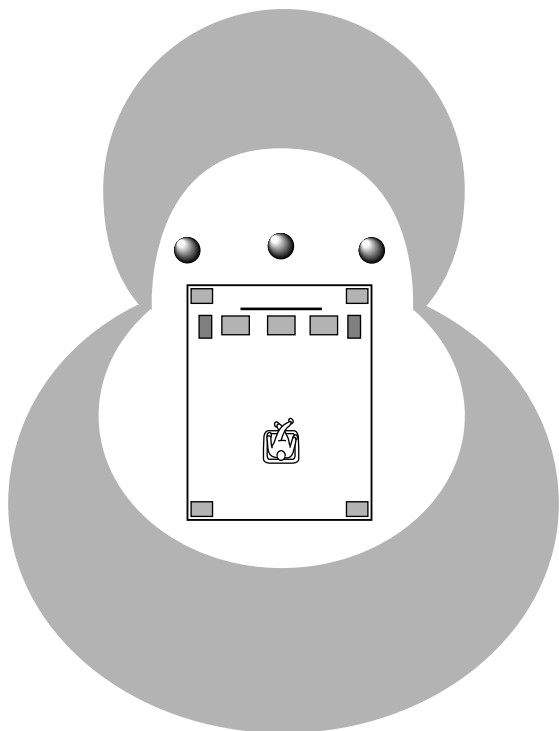

Dolby Digital (AC-3) + 3 Digital Sound Fields

Digital sound fields are created on the presence side and the independent left and right surround sides of the Dolby Digital (AC-3)-decoded sound field respectively. They create a wide acoustic environment and much surround effect in the room without losing high channel separation. With wide dynamic range of Dolby Digital (AC-3) sound, this sound field combination lets you feel as if you are watching a movie in the newest Dolby Stereo Digital theater. This will be the most ideal home theater sound at the present time.

This combination is available when the sound field program No. 2, No. 3 or No. 4 is selected, and the input signal of source is encoded with the Dolby Digital (AC-3) (except in 2-channels).

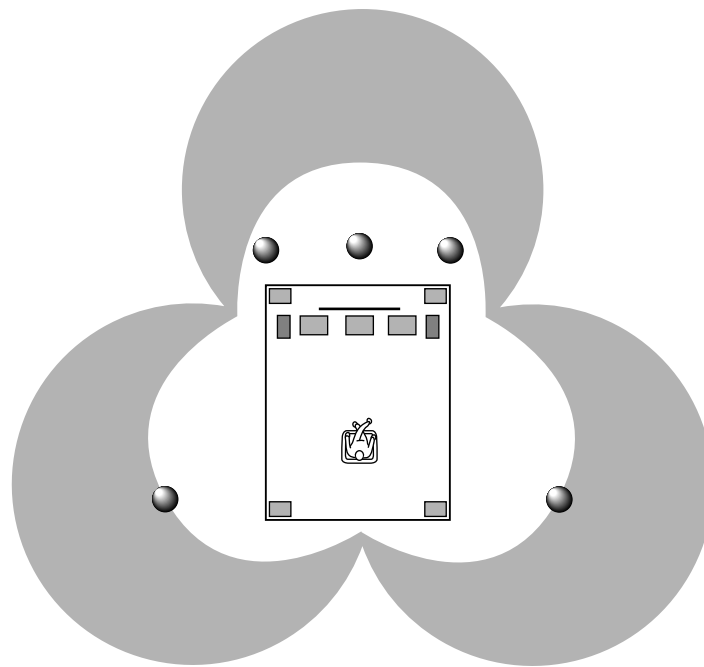

Video superimpose

If you connect your video cassette recorder, LD player, video monitor, etc. to this unit, you can take advantage of this unit's capability to display program titles and information for various setting changes and adjustments on your video monitor's screen. This information will be superimposed over the video image.

If there is no video source connected or it is turned off, the information will be displayed over a blue colored background.

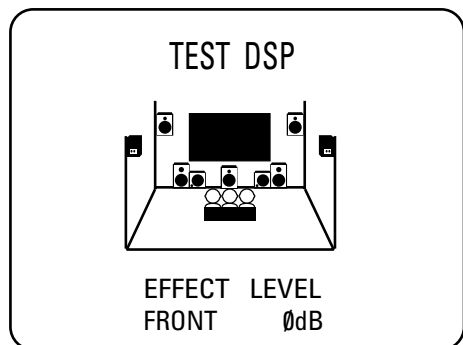

NOTE: The program titles and other information are also displayed on the display panel of this unit.

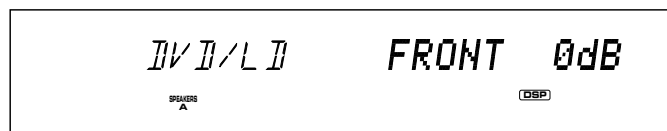

SPEAKER SETUP

Setting Up Your Speaker System

This unit has been designed to provide the best sound field quality with a full seven-speaker system setup, using two extra pairs of effect speakers to generate the sound field plus one center speaker for dialog. We therefore recommend that you use a seven-speaker setup. A four-speaker system using only one pair of effect speakers for the sound field will still provide impressive ambience and effects, however, and may be a good way to begin with this unit. You can always upgrade to the full seven speaker system later. In the 4 or 5 speaker system, the Digital Sound Field Processing is still performed, but the main speakers are used for both the main channels and the front effect channels.

Use of the Center Dialog Speaker Is Recommended

When playing back a source with the DSP programs No. 1 through No. 4, or when the Dolby Digital (AC-3) is decoded with any DSP program used, if the source contains center-channel signals, dialog, vocals etc. are output from the center channel. Therefore, if you want to maximize the performance of your Audio/Video home theater system, it is recommended that you use a center channel speaker.

If for some reason it is not practical to use a center speaker, it is possible to enjoy movie viewing without it. Best results, however, are obtained with the full system.

Use of a Subwoofer Expands Your Sound Field

It is also possible to further expand your system with the addition of a subwoofer and amplifier. The use of a subwoofer is effective not only for reinforcing bass frequencies from any or all channels, but also for reproducing the LFE (low frequency effect) sound with high fidelity when playing back a source with the Dolby Digital (AC-3) decoded. You may wish to choose the convenience of a Yamaha Active Servo Processing Subwoofer System, which has its own built-in power amplifier.

Four Possible Types of Speaker System Configurations Recommended

4 Speaker System

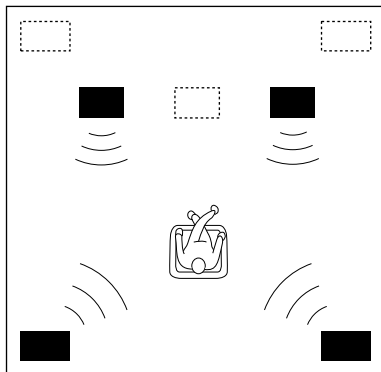

Simplest system.

You can enjoy widely diffused sound by only adding two additional speaker units at the rear.

FRONT MIX switch—Set to ON.
(See page 22.)
CENTER SPEAKER—Set to PHNTM.
(See page 35.)

5 Speaker System

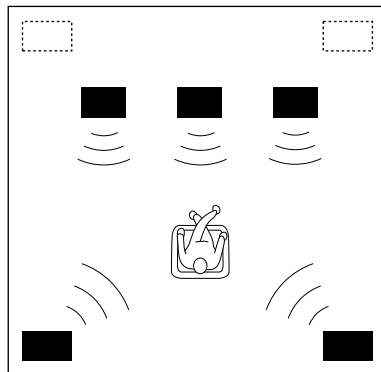

Good for Audio/Video sources.

By the use of center speaker, center sounds (dialog, vocals etc.) are precisely localized.

FRONT MIX switch—Set to ON.
(See page 22.)
CENTER SPEAKER—Set to NRML or WIDE. (See page 35.)

6 Speaker System

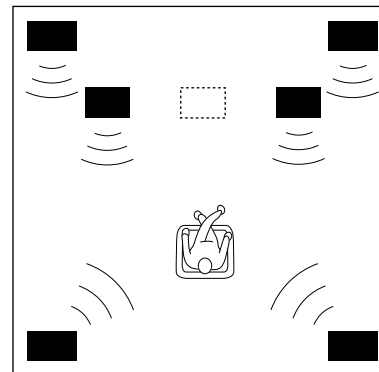

Good for sound fields from 2-channel stereo sources.

When a normal stereo source is played back with the sound field programs No. 5 through No. 10, a sound effect matching that of a 7-speaker system can be obtained. The addition of front left and right effect speakers produces a more effective sound field.

FRONT MIX switch—Set to OFF.
(See page 22.)
CENTER SPEAKER—Set to PHNTM.
(See page 35.)

7 Speaker System

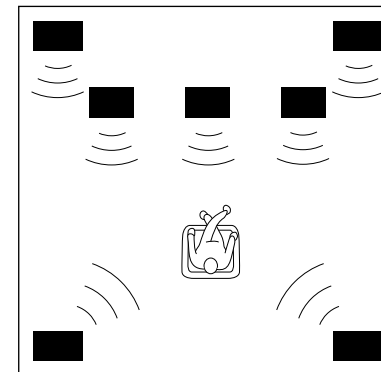

This is the recommended speaker system, providing the best sound effects.

When a normal stereo source is played back with the sound field programs No. 5 through No. 10, using both sets of effect speakers (front and rear), reproduces the most effective sound field. When using the sound field programs No. 1 through No. 4 or when using any program with the Dolby Digital (AC-3) decoded, the center speaker provides precise center localization.

FRONT MIX switch—Set to OFF.
(See page 22.)
CENTER SPEAKER—Set to NRML or WIDE. (See page 35.)

Speakers and Speaker Placement

Your full seven-speaker system will require three speaker pairs: the MAIN SPEAKERS (your normal stereo speakers), the FRONT EFFECT SPEAKERS and the REAR SPEAKERS, plus the CENTER SPEAKER. You may also be using a subwoofer.

The MAIN SPEAKERS should be high performance models and have enough power handling capacity to accept the maximum output of your audio system.

Other speakers do not have to be equal to the MAIN SPEAKERS. For precise sound localization, however, it is ideal to use high performance models that can reproduce sounds in full range for the CENTER SPEAKER and the FRONT EFFECT and REAR SPEAKERS.

Place the MAIN SPEAKERS in the normal position.

Place the FRONT EFFECT SPEAKERS further apart than the MAIN SPEAKERS, on either side of and a few feet behind and above the MAIN SPEAKER pair.

Place the REAR SPEAKERS behind your listening position. They should be nearly six feet up from the floor.

Place the CENTER SPEAKER precisely between the two MAIN SPEAKERS. (To avoid interference, keep the speaker above or below the television monitor, or use a magnetically shielded speaker.)

If using a SUBWOOFER, such as a Yamaha Active Servo Subwoofer System, the position of the speaker is not so critical because low bass tones are not highly directional.

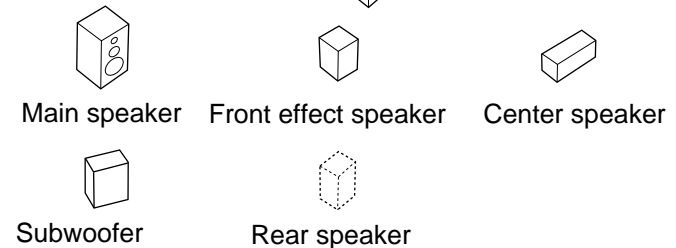
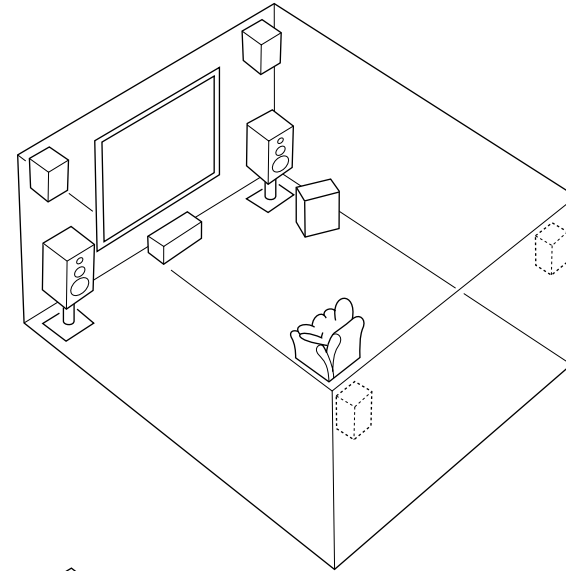

CONTROLS & THEIR FUNCTIONS

FRONT PANEL

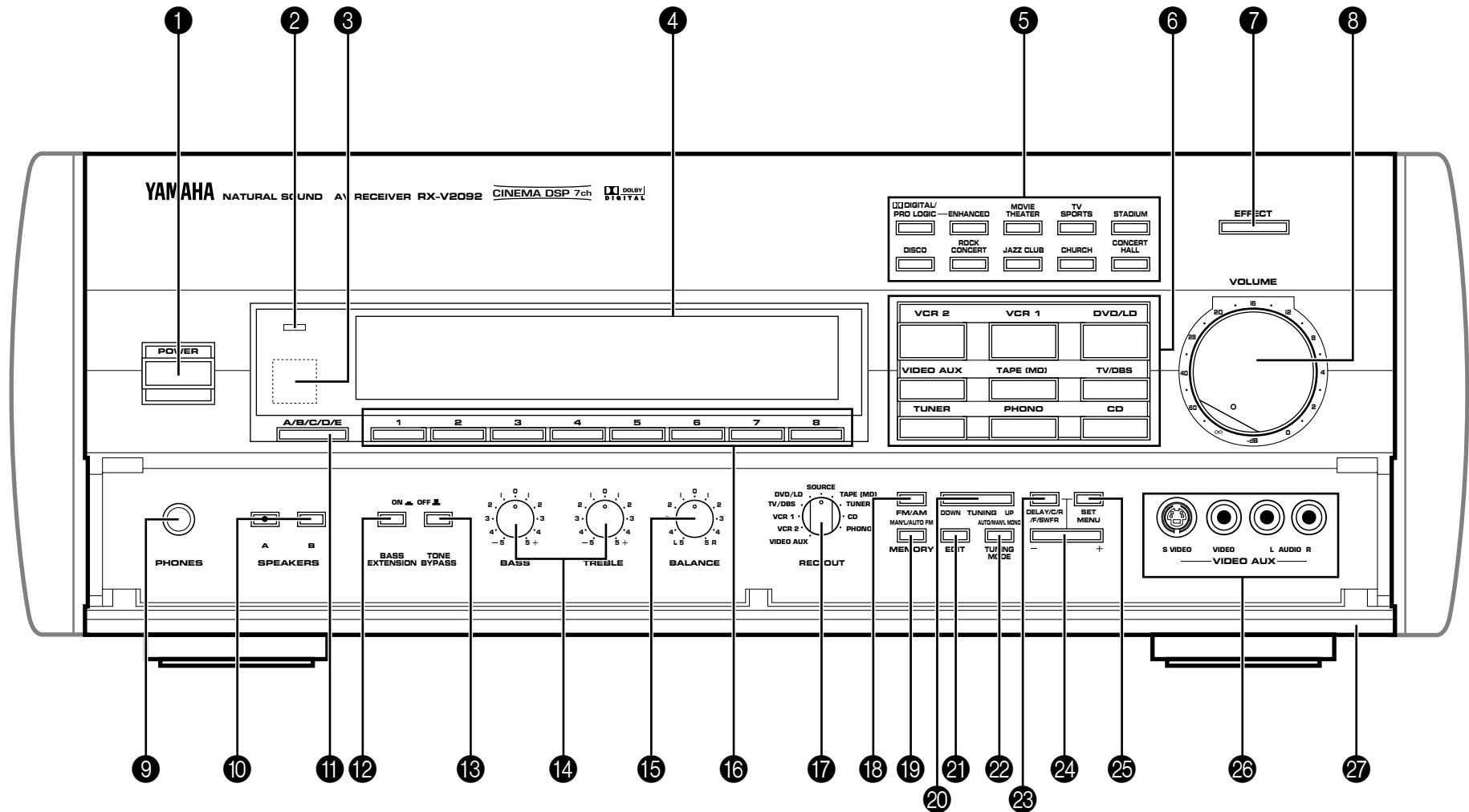

(General Model)

* For control keys on the remote control unit, see pages 62 to 64.

1 POWER Switch

Turns this unit on and off.

* When you press this switch to turn the power on, you will hear a click and a sound of the built-in fan rotating for a moment.

2 Standby Indicator (Except U.S.A. and Canada models)

While the power of this unit is on, pressing the (SYSTEM POWER) OFF key on the remote control unit switches this unit to the standby mode. In this mode, the standby indicator is illuminated.

3 Remote Control Sensor

Signals from the remote control unit are received here.

4 Display Panel

See pages 16 to 17.

5 DSP Program Selector Buttons

Select a DSP program. When a button is pressed, the name of selected program lights up on the display panel.

6 Input Selector Buttons

Selects an input source that you want to listen to (and watch).

7 EFFECT Switch

Normally ON, this switch can be turned OFF to disable output from the center and effect speakers so that the sound becomes normal 2-channels.

* Even if this switch is off, when the Dolby Digital (AC-3) is decoded, signals at all channels are distributed to the main channels and output from the main speakers.

8 Master VOLUME Control

Simultaneously controls volume level at all outputs: front effect, main, rear effect, center, and subwoofer. (This does not affect REC OUT level.)

* When the volume is decreased by pressing the MUTE key on the remote control unit, the indicator on the master VOLUME control flashes on and off.

9 PHONES Jack

When you listen with headphones, connect the headphones to the PHONES jack. You can listen to the sound to be output from the main speakers through headphones.

When listening with headphones privately, set both the SPEAKERS A and B switches to the OFF position and switch off the digital sound field processor (so that no DSP program name is illuminated on the display panel) by pressing the EFFECT switch.

10 SPEAKERS Switches

Set the switch A or B (or both A and B) for the main speakers (connected to this unit) you will use to the ON position. Set the switch for the main speakers you will not use to the OFF position. Selected main speakers are shown by the lighting of "SPEAKERS A" and/or "SPEAKERS B" on the display panel.

11 A/B/C/D/E Switch

Press this switch to select a desired group (A–E) of preset stations.

12 BASS EXTENSION Switch

When pressed inward (ON), boosts bass frequency response at the main left and right channels while maintaining overall tonal balance. If you do not have a subwoofer, the use of this switch will be effective to reinforce the bass frequencies.

- 13** TONE BYPASS switch
When this switch is pressed inward (ON), the input signal does not pass through the tone (BASS and TREBLE) control circuitry so that it is unaffected by the tone control circuitry. Use this switch to obtain pure sound and to check the tone control setting. Press this switch to release it outward (OFF) to use the tone control circuitry.
- 14** BASS and TREBLE Controls
Adjust low and high frequency response respectively for the main channels only.
- 15** BALANCE Control
Adjusts the left and right output volume to the Main Speakers to compensate for sound imbalance caused by speaker positions or listening room conditions.
- 16** Preset Station Number Selector Buttons
Select a preset station number (1 to 8).
- 17** REC OUT Selector
Selects the source to be recorded to a tape deck or VCR independently of the setting of the input selector buttons. However, when set to the SOURCE position, the setting of the input selector buttons decides the source to be recorded to a tape deck or VCR.
- 18** FM/AM Switch
Press this switch to switch the reception band to FM or AM.
- 19** MEMORY (MAN'L/AUTO FM) Button
When this button is pressed, the MEMORY indicator flashes for about 5 seconds. During this period, select a desired preset station number by pressing the corresponding preset station number selector button to enter the displayed station into the memory.
When this button is pressed and held for about 3 seconds, the automatic preset tuning begins. (Refer to page 52 for details.)
- 20** TUNING DOWN/UP Button
Used for tuning. Press the "UP" side to tune in to higher frequencies, and press the "DOWN" side to tune in to lower frequencies.
- 21** EDIT Button
This button is used to exchange the places of two preset stations with each other.
- 22** TUNING MODE (AUTO/MAN'L MONO) Switch
Press this switch to switch the tuning mode to automatic or manual. To select the automatic tuning mode, press this switch so that "AUTO TUNING" lights up on the display panel. To select the manual tuning mode, press this switch so that "AUTO TUNING" goes off.
- 23** DELAY/C/R/F/SWFR Switch
Whenever pressed, selects the item of changing delay time, center speaker output level, rear speaker output level, front effect speaker output level and subwoofer output level in turn.
* Depending on a mode of this unit, the number of selections is reduced. For example, when the built-in digital sound field processor (including the Dolby Pro Logic Decoder or the Dolby Digital (AC-3) Decoder) is off, only the item for changing subwoofer output level can be selected.
- 24** -/+ Button
Adjusts the level of item selected by pressing the DELAY/C/R/F/SWFR switch. Moreover, performs setting changes and adjustments for functions selected by pressing the SET MENU switch.
- 25** SET MENU Switch
Whenever pressed, selects functions in the SET MENU mode.

- 26 Auxiliary Input Jacks (VIDEO AUX)
 Connect an auxiliary video or audio unit such as a camcorder to these jacks. If the connected video unit has a S video output terminal, connect it to the S VIDEO jack to obtain a high resolution picture. The unit connected to these jacks can be selected by the corresponding input selector button and REC OUT selector.

- 27 Control Door
 See page 4 for how to open and close the control door.

DISPLAY PANEL

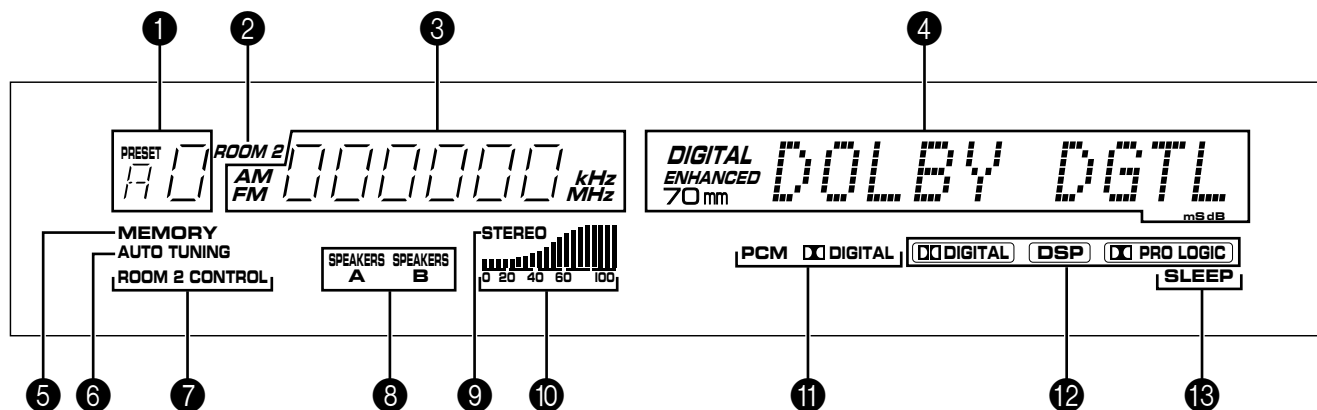

- 1 Preset Station Number Display
 Shows the selected preset station number (1 to 8) and its group (A to E).
- 2 ROOM 2 Indicator
 Lights up when you switch the input source for the second room by using the Room 2 remote control unit in the main room.
- 3 Input Source/Station Frequency Display
 Shows the currently selected input source, or the currently selected station frequency and the band (FM or AM) when this unit is in the tuner input source mode.
- 4 Multi-information Display
 Shows the currently selected DSP program, or information for several adjustments or setting changes made on this unit.

- ⑤ **MEMORY Indicator**
When the MEMORY button is pressed, this indicator flashes for about 5 seconds. During this period, the displayed station can be programmed to the memory by using the A/B/C/D/E switch and the preset station number selector buttons.
- ⑥ **AUTO TUNING Indicator**
Lights up when this unit is in the automatic tuning mode.
- ⑦ **ROOM 2 CONTROL Indicator**
Lights up momentarily when the Room 2 remote control unit is used in the second room.
- ⑧ **SPEAKERS A/B Indicators**
The indicator A or B which corresponds to the currently selected main speakers lights up. If both main speakers A or B are selected, both indicators light up.
- ⑨ **STEREO Indicator**
Lights up when an FM stereo broadcast with sufficient signal strength is received.
- ⑩ **Signal-level Meter**
Indicates the signal level of the received station.
If multipath interference is detected, the indication decreases.
- ⑪ **Digital Audio Input Signal Indicators**
When digital audio signals not encoded with the Dolby Digital (AC-3) are input to this unit, "PCM DIGITAL" lights up.
When digital audio signals encoded with the Dolby Digital (AC-3) are input to this unit, "DOLBY DIGITAL" lights up.
- ⑫ **DOLBY DIGITAL, DSP and DOLBY PRO LOGIC indicators**
"DOLBY DIGITAL" lights up when the built-in Dolby Digital (AC-3) Decoder is on and the signals of selected source encoded with the Dolby Digital (AC-3) is not in 2-channels. "DSP" lights up when the built-in digital sound field processor is on, and "DOLBY PRO LOGIC" lights up when the built-in Dolby Pro Logic Surround Decoder is on. Depending on the selected DSP program, both "DOLBY DIGITAL" and "DSP", or both "DSP" and "DOLBY PRO LOGIC" will light up.
- ⑬ **SLEEP Indicator**
Lights up while the built-in SLEEP timer is functioning.

CONNECTIONS

REAR PANEL PARTS AND THEIR FUNCTIONS

Before you start making connections make sure all related electronic components are turned OFF.

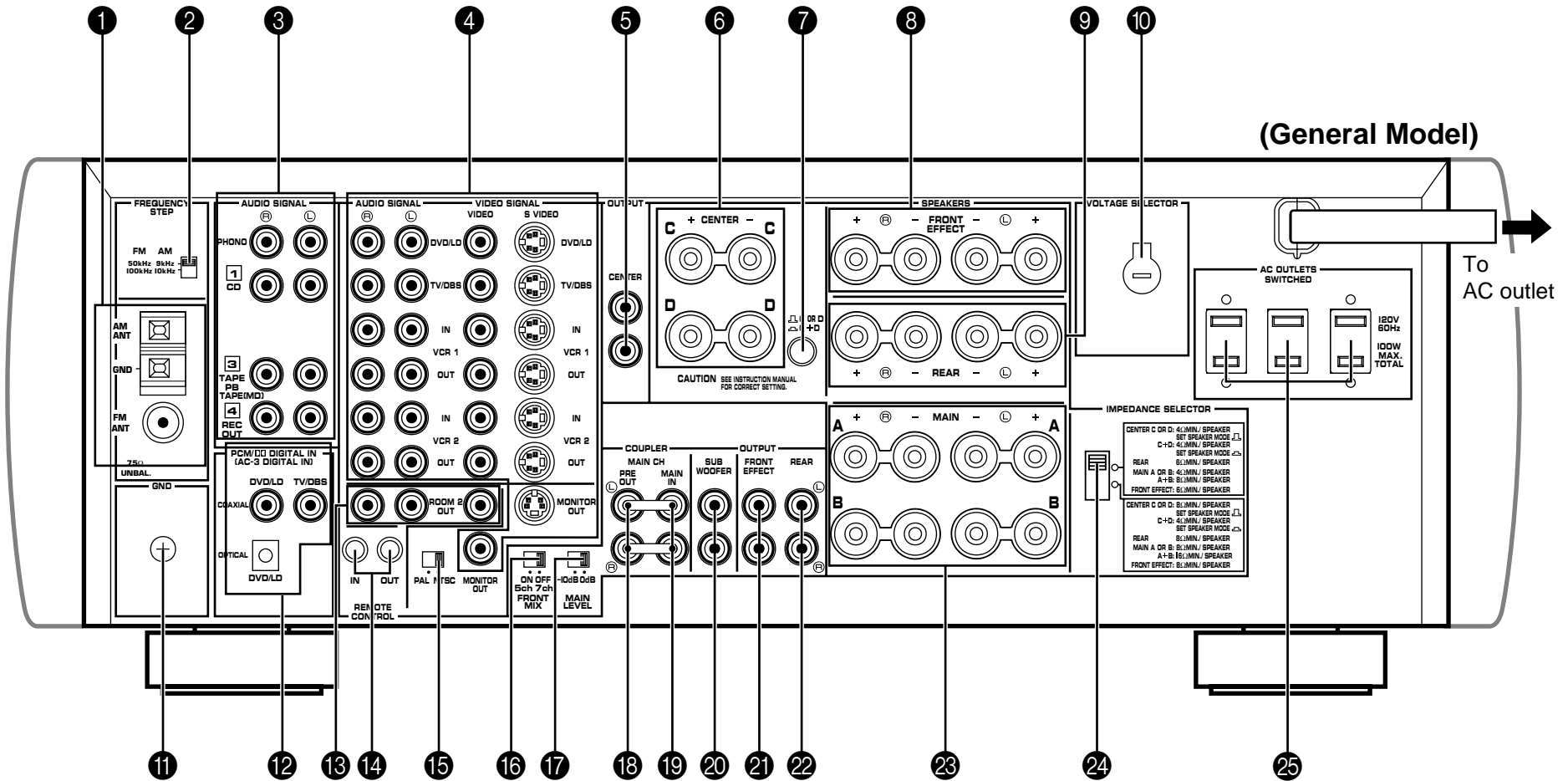

- 1** **Antenna Connection Terminals**
Connect the included indoor FM antenna to the FM ANT terminal and connect the included AM loop antenna to the AM ANT and GND terminals. To heighten safety and reduce interference, connect the GND terminal to a good earth ground. For improving reception quality, you can connect outdoor FM and/or AM antenna to these terminals (See pages 27 to 29 for details.)
- 2** **FREQUENCY STEP Switch (General Model only)**
Because the interstation frequency spacing differs in different areas, set this switch to the position suitable for the frequency spacing in your area.
Before sliding this switch, disconnect the AC power plug of this unit from the AC outlet.
- 3** **AUDIO SIGNAL Connection Jacks (for Audio Source Equipment)**
Connect the inputs and/or outputs of your audio equipment.
- 4** **AUDIO/VIDEO SIGNAL Connection Jacks (for Video Source Equipment)**
Connect the audio and video inputs and/or outputs of your video equipment. In place of the VIDEO jacks, the S VIDEO jacks can be used for higher resolution and improved picture quality if your VCR, monitor, etc. are equipped with S-VIDEO connectors.
- 5** **CENTER OUTPUT Jacks**
Center-channel line outputs. Can be connected to input jack(s) of one or two external power amplifier(s) to drive the center speaker(s).
- 6** **CENTER SPEAKERS Terminals**
When using the built-in center-channel amplifier, connect one or two center speakers here.
- 7** **Center Speaker Switch**
Set to “C + D” when using two center speakers, or to “C OR D” when using only one center speaker.
- 8** **FRONT EFFECT SPEAKERS Terminals**
When using the built-in front effect-channel amplifier, connect the front effect speakers here.
- 9** **REAR SPEAKERS Terminals**
When using the built-in rear-channel amplifier, connect the rear speakers here.
- 10** **VOLTAGE SELECTOR (General Model only)**
Be sure to set to the line voltage in your area before applying power. Consult your dealer if unsure of the correct setting.
- 11** **GND Terminal**
Connects the ground wire of the turntable to produce minimum hum. In some cases, however, better results may be obtained with the ground wire disconnected.
- 12** **PCM/  DIGITAL IN (COAXIAL and OPTICAL) jacks**
Can be connected with audio/video units that have a coaxial or optical digital output jack. Connect a unit that is connected to the DVD/LD AUDIO/VIDEO SIGNAL connection jacks to the DVD/LD COAXIAL or OPTICAL jack.
Connect a unit that is connected to the TV/DBS AUDIO/VIDEO SIGNAL connection jacks to the TV/DBS COAXIAL jack.
* If, for example, your LD player has an AC-3 RF output jack and no digital output jack for AC-3 discrete audio signals, connect the AC-3 RF output jack to the DVD/LD COAXIAL or OPTICAL jack of this unit by way of an RF demodulator (separate purchase).

13 ROOM 2 OUT Jacks

These jacks output audio and video signals to the equipment in the second room. The input source selection is made using the Room 2 remote control unit. Refer to “CONNECTING AND CONTROLLING ROOM 2 EQUIPMENT” on page 38.

14 REMOTE CONTROL IN and OUT Jacks

The IN jack receives the commands from the Room 2 remote control unit. The OUT jack outputs the commands at the IN jack from the Room 2 remote control unit. Refer to “CONNECTING AND CONTROLLING ROOM 2 EQUIPMENT” on page 38.

15 Video NTSC/PAL Switch (General Model only)

Set this switch to the position corresponding to the standard that your video equipment employs.

16 FRONT MIX Switch

Set to “OFF (7ch)” when setting up a full 7 or 6 speaker system, or to “ON (5ch)” when setting up a 5 or 4 speaker system.

17 MAIN LEVEL Switch

Normally set to “0 dB”. If desired, you can decrease the main-channel output level at the MAIN SPEAKERS terminals by 10 dB by setting this switch to “-10 dB”.

18 PRE OUT Jacks

Main-channel line output. Connected with jumper bars to MAIN IN jacks when the built-in amplifier is used. Connected to input jacks of external stereo power amplifier (MAIN IN or TAPE PLAY jacks of integrated amplifier or receiver) when using external amplification.

19 MAIN IN Jacks

Line input to built-in main-channel amplifier. Connected with jumper bars to PRE OUT jacks when the built-in amplifier is used. Not connected when using an external power amplifier.

20 SUBWOOFER Jacks

When using one subwoofer, connect its amplifier input to either of these jacks. When using two subwoofers, connect their amplifiers to these jacks respectively.

Frequencies below 90 Hz distributed from the main, center and/or rear channels are output to these jacks.

Signals of LFE (low frequency effect) generated when the Dolby Digital (AC-3) is decoded are also output if they are assigned to these jacks.

21 FRONT EFFECT OUTPUT Jacks

Front-channel line output. Can be connected to input jacks of an external stereo power amplifier driving the front effect speakers.

- ②② REAR OUTPUT Jacks
Rear-channel line output. Can be connected to input jacks of an external stereo power amplifier driving the rear speakers.
- ②③ MAIN SPEAKERS Terminals
This unit is equipped with 2 sets of MAIN SPEAKERS terminals to allow you to connect 2 main speaker systems to this unit. When using this unit's built-in main-channel amplifier, connect the main speakers here. The jumper bars must be plugged in to connect the MAIN IN jacks to the PRE OUT jacks.
- ②④ IMPEDANCE SELECTOR Switch
Select the position whose requirements your speaker system meets.
- ②⑤ SWITCHED AC OUTLET(S)
You may plug other audio/video units into these sockets as long as their combined power consumption does not exceed the specified value shown. "Switched" means that these components are turned on and off by this unit's power switch.

REAR PANEL SWITCH AND CONTROL SETTINGS

There are several switches and controls on the rear panel that you'll have to check before operating your system, and it's a good idea to do it before you connect cables. Locate the MAIN LEVEL slide switch (17) and FRONT MIX slide switch (16). Make sure the MAIN LEVEL switch is set to "0 dB" and the FRONT MIX switch is set to "OFF" for 7 or 6 speaker driving.

In a 5 or 4 speaker system, set the FRONT MIX switch to "ON".

For General model only, set the NTSC/PAL switch (15) to the position corresponding to the standard which your video equipment employs and set the FREQUENCY STEP switch (2) to the position suitable for the frequency spacing in your area.

For the setting of IMPEDANCE SELECTOR switch (24), see page 34.

For the setting of the center speaker switch (7), see page 32.

GENERAL INSTRUCTIONS FOR CONNECTIONS

Make sure that you have the left (L) and right (R) channels correctly connected. That means that jacks marked "L" on this unit must be connected to jacks marked "L" on other units. Likewise with the "R" jacks. This is easy if you remember to always use the red plug for the "R" jacks and the white plug for the "L" jacks.

For connections with audio/video source equipment, use RCA type pin plug cables with the exception described later.

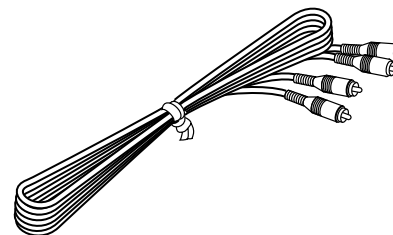

With speaker connections you must also be sure that the polarity is correct. For each amplifier and each channel, connect the plus (+) terminal of the amplifier to the plus terminal of the speaker, and connect the minus (-) terminal of the amplifier to the minus terminal of the speaker. To keep track of polarity, use a speaker cable that has one of the two wires marked by a stripe or a different color.

CONNECTING AUDIO/VIDEO SOURCE EQUIPMENT TO THIS UNIT

BASIC CONNECTIONS

* If you have YAMAHA audio/video unit numbered as 1, 3 or 4 on the rear panel, connections can be made easily by making sure to connect the output (or input) terminals of each unit to the same-numbered terminals of this unit.

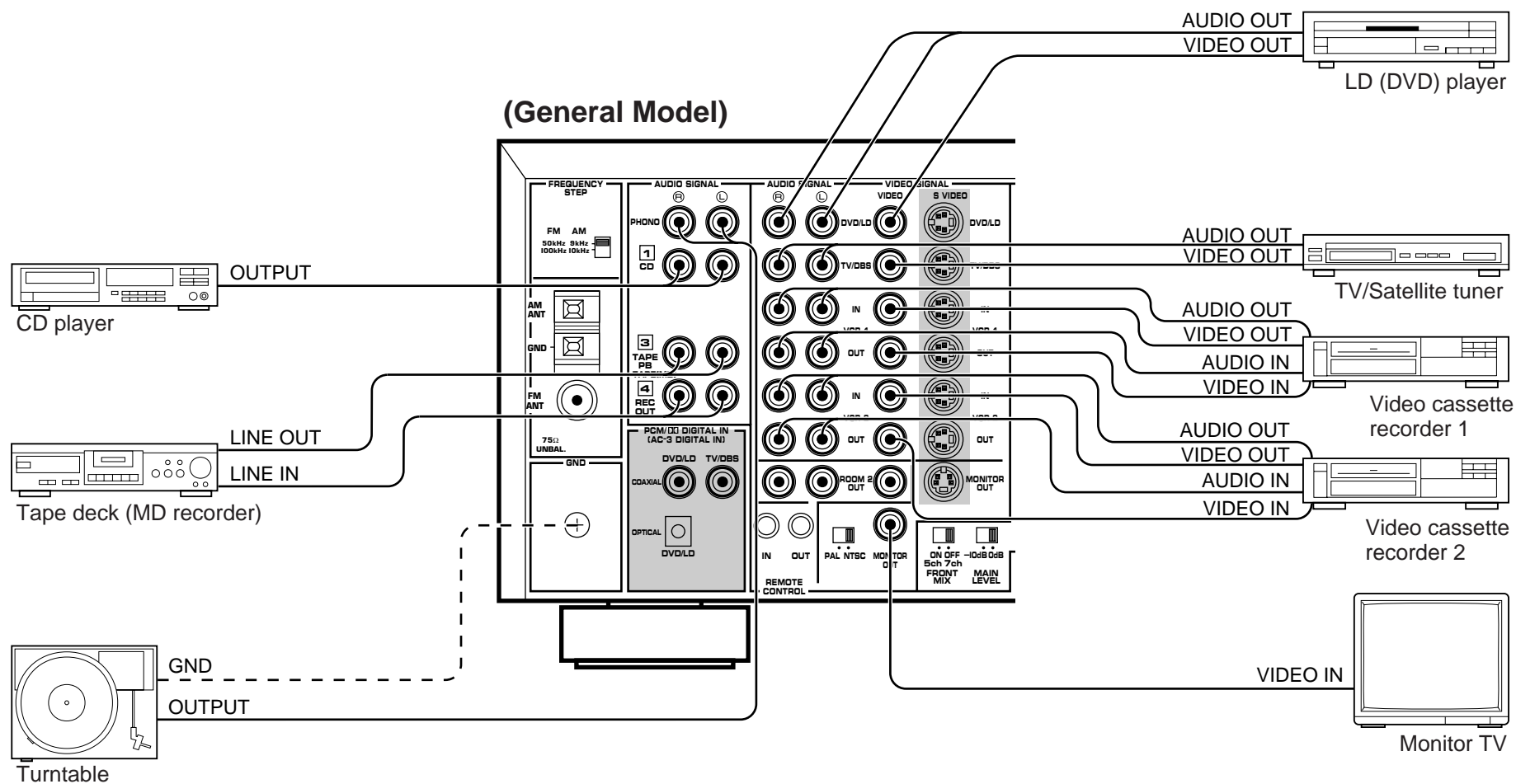

* For shaded parts, see pages 24 to 26.

CONNECTING TO DIGITAL (OPTICAL AND COAXIAL) JACKS

If your LD (DVD) player, TV/satellite tuner, etc. are equipped with coaxial or optical digital audio signal output jacks, they can be connected to this unit's COAXIAL and/or OPTICAL digital signal input jacks.

To make a connection between optical digital audio signal jacks, remove the cover from each jack, and then connect them by using a commercially available optical fiber cable that conforms to EIAJ standards. Other cables might not function correctly.

Even if you connect an audio/video unit to the OPTICAL (or COAXIAL) jack of this unit, you must keep the unit connected with the same named analog audio signal jacks of this unit, because digital signal cannot be recorded by a tape deck or VCR connected to this unit, and digital signal also will not be output from the AUDIO SIGNAL ROOM 2 OUT jacks. You can switch the selection of input signals between "digital" and "analog" easily. (See page 47 for details.)

NOTE: When connecting an audio/video unit to both of the digital and analog jacks of this unit, make sure to connect to both jacks of the same name.

NOTE: Be sure to attach the cover when the OPTICAL jack is not being used, in order to protect the jack from dust.

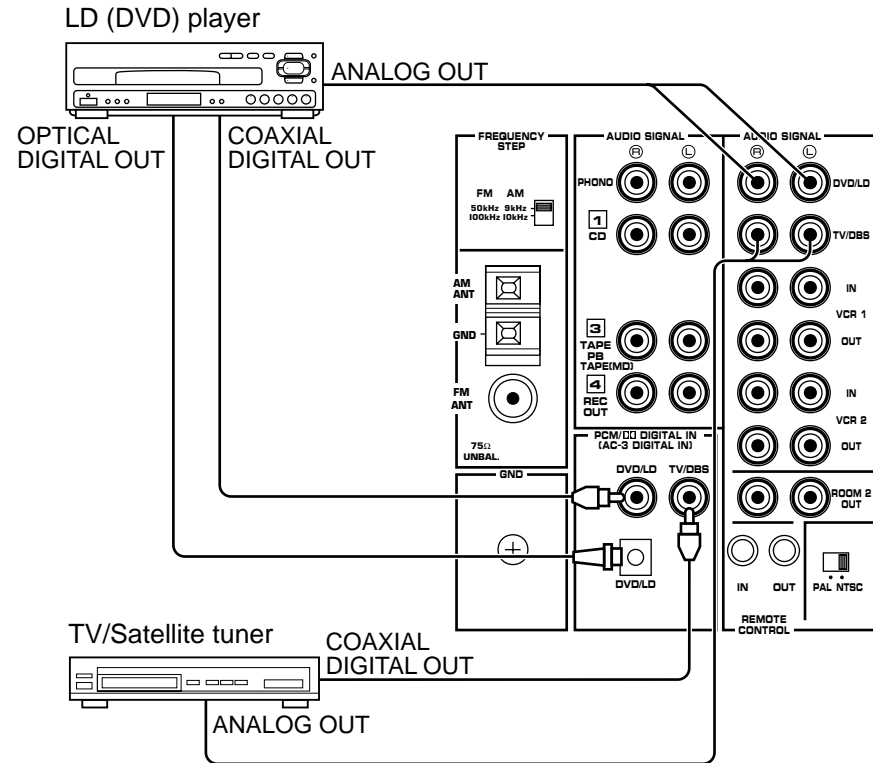

NOTE: All digital audio signal input jacks are applicable to the sampling frequency of 32 kHz, 44.1 kHz and 48 kHz.

Notes on connecting with an LD player equipped with an AC-3 RF output

If your LD player has AC-3 RF signal output jack and no digital signal output jack for AC-3 discrete audio signals, connect the AC-3 RF signal output jack to this unit's OPTICAL (or COAXIAL) digital signal input jack by using an RF demodulator (separate purchase). First, connect the AC-3 RF signal output jack of the LD player to the AC-3 RF signal input jack of the RF demodulator. Next, connect the optical (or coaxial) digital signal output jack of the RF demodulator to the OPTICAL (or COAXIAL) digital signal input jack of this unit.

This connection is necessary for inputting audio signals encoded with the Dolby Digital (AC-3) on the LD player to this unit.

It is also necessary to connect the LD player to this unit's analog audio signal input jacks regardless of the AC-3 RF signal connection, for playing back an LD source with the Dolby Pro Logic Surround decoded or in normal stereo (or monaural).

If desired, you can also connect the digital signal output jack (for 2-channel audio signals) of the LD player to this unit. If you will do so, connect it to the COAXIAL digital signal input jack of this unit, and connect the RF demodulator to the OPTICAL digital signal input jack of this unit.

By this connection, if the input mode of the DVD/LD source is in "AUTO", you can enjoy listening to sounds decoded with the Dolby Digital (AC-3) when you play a disc encoded with the Dolby Digital (AC-3) though signals are input to both OPTICAL and COAXIAL digital signal input jacks of this unit simultaneously (because signals input to the OPTICAL jack take priority of signals input to the COAXIAL jack).

See page 47 for details about switching the input mode.

NOTES

- If, for example, you play a CD on the LD player (which can play a CD also), there is no input to the OPTICAL jack, so the signals input to the COAXIAL jack take priority. In this case, switch off the RF demodulator to listen to CD sound surely. However, if your RF demodulator is the Yamaha model APD-1, you do not have to switch it off.
- When you want to play a source encoded with the Dolby Digital (AC-3) without decoding the Dolby Digital (AC-3), you must switch off the power to the RF demodulator.

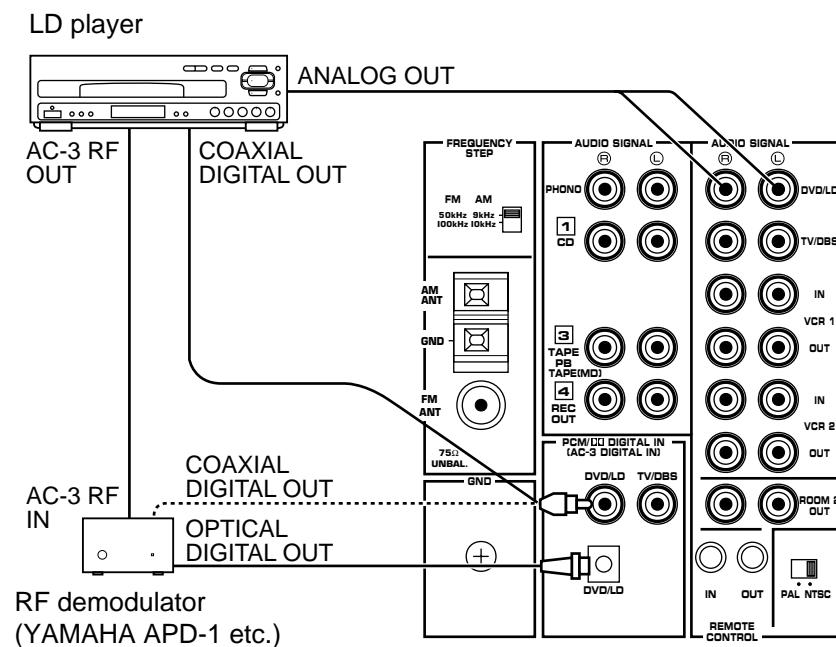

CONNECTING TO S VIDEO JACKS

If your video cassette recorder, LD player, etc. and your monitor are equipped with “S” (high-resolution) video terminals, connect them to this unit’s S VIDEO jacks, and connect this unit’s S VIDEO MONITOR OUT jack to the “S” video input of your monitor. Otherwise, connect the composite video jacks from your video cassette recorder, LD player, etc. to the VIDEO jacks of this unit, and connect this unit’s VIDEO MONITOR OUT jack to the composite video input of your monitor.

NOTE: If video signals are sent to both S VIDEO input and VIDEO input jacks, the signals will be sent to their respective output jacks independently.

NOTE: If your unit is the General Model, be sure the NTSC/PAL switch has been correctly set to the standard that your video equipment employs. U.S.A. and Canada models have no switch and use the NTSC standard, while other models without a switch use the PAL standard.

Notes about the Video superimpose

- If you watch a video source that is connected to both S VIDEO and VIDEO input jacks of this unit, signals of screen display information are output from only the S VIDEO MONITOR OUT jack.
 - When no video signal is input to either S VIDEO or VIDEO input jacks of this unit, signals of screen display information are output from both S VIDEO MONITOR OUT and VIDEO MONITOR OUT jacks with a color background.
- * For the General Model, if the NTSC/PAL switch on the rear panel is set to “PAL”, nothing will be output from either S VIDEO MONITOR OUT or VIDEO MONITOR OUT jack in this case.

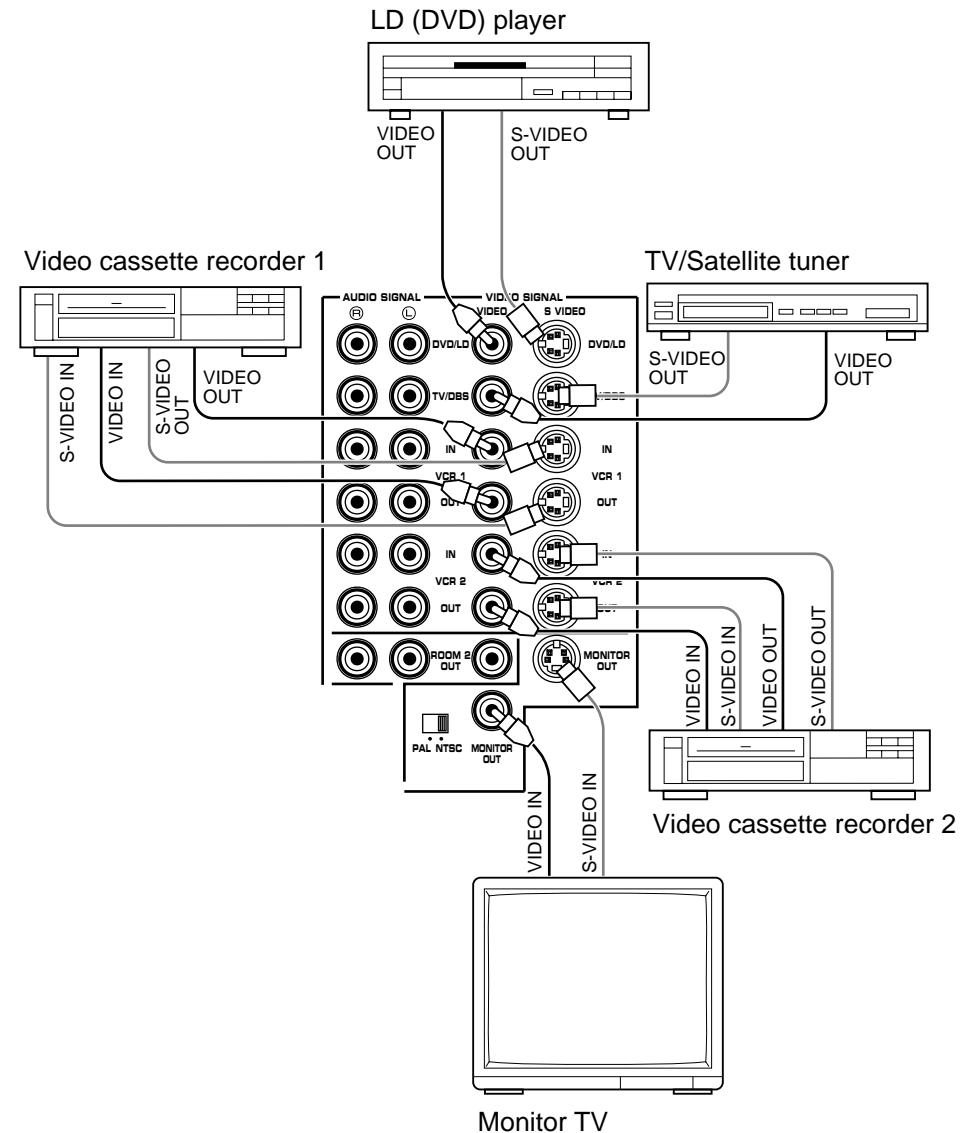

ANTENNA CONNECTIONS

- Each antenna should be connected to the designated terminals correctly, referring to the following figure.
- Both AM and FM indoor antennas are included with this unit. In general, these antennas will probably provide sufficient signal strength. Nevertheless, a properly installed outdoor antenna will give clearer reception than an indoor one. If you experience poor reception quality, an outdoor antenna may result in improvement.

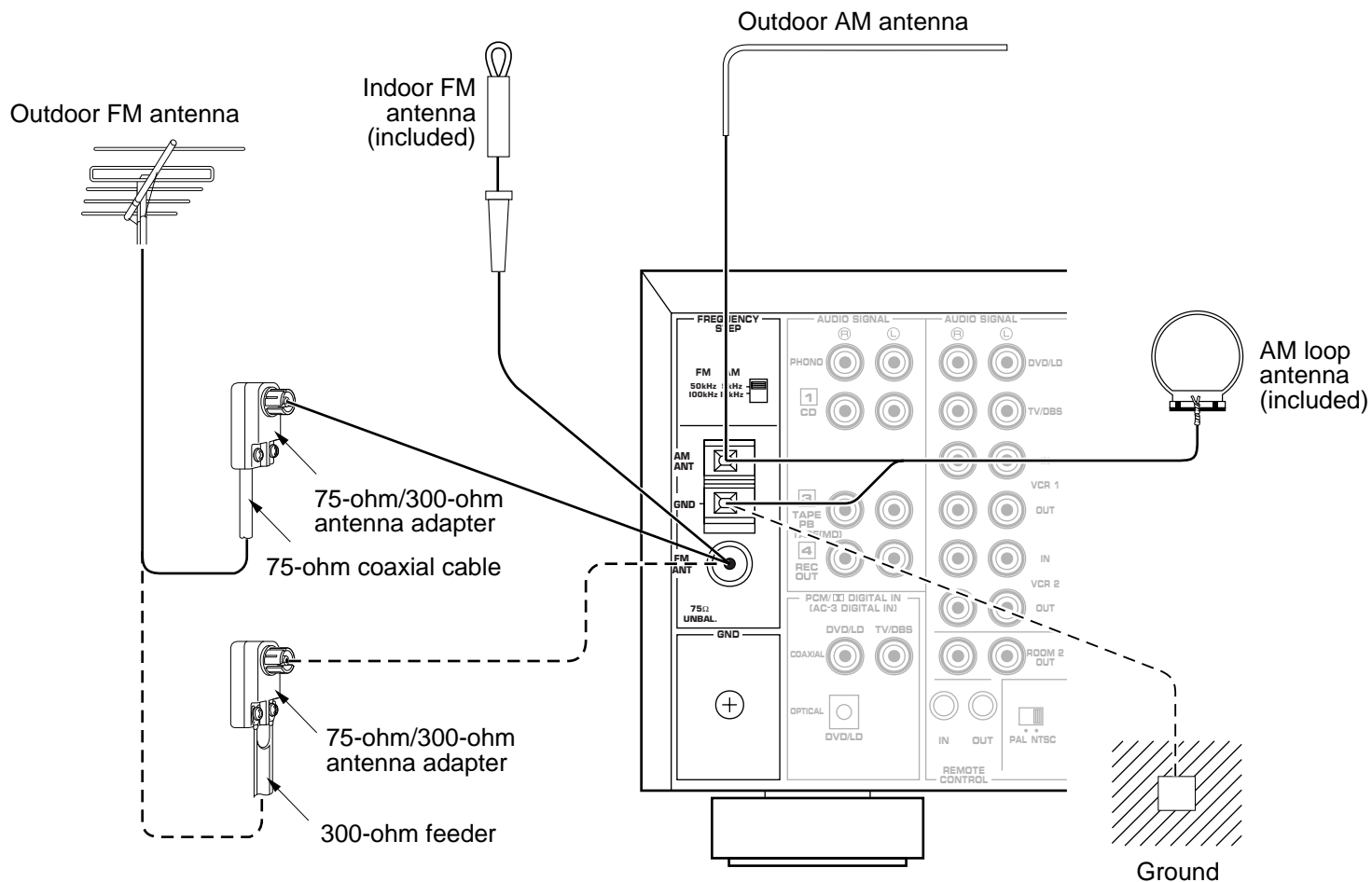

Connecting the indoor FM antenna

Connect the included indoor antenna to the 75Ω UNBAL. FM ANT terminal.

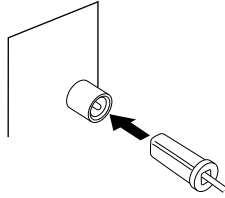

NOTE

If you connect an outdoor FM antenna to this unit, do not connect the indoor FM antenna to this unit.

Connecting the AM loop antenna

1. Press the tab and unlock the terminal hole.
2. Connect the AM loop antenna lead wires to the AM ANT and GND terminals.
3. Return the tab back to the original position to lock the lead wires. Lightly pull on the lead wires to confirm a good connection.

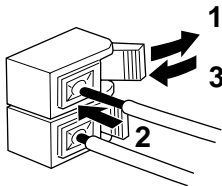

4. Attach the loop antenna to the antenna stand.

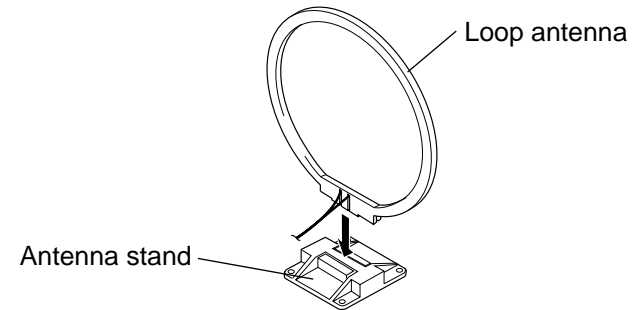

5. Tune to an AM station and then position the loop antenna for best reception. Orient the AM loop antenna so that the best reception is obtained. Try other stations, and find the position that gives the best overall reception.

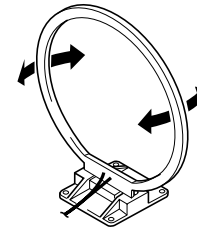

NOTES

- The AM loop antenna should be placed apart from the main unit. The antenna may be hung on a wall.
- The AM loop antenna should be kept connected, even if an outdoor AM antenna is connected to this unit.

Optional outdoor FM antenna

Consult with your dealer or authorized service center about the best method of selecting and erecting an outdoor FM antenna. The choice of the feeder cable is also important. Flat ribbon-shaped twin-lead cable performs well electrically, and is cheaper and somewhat easier to handle when routing it through windows and around rooms. Coaxial cable is more expensive, does a much better job of minimizing interference, is less prone to the effects of weather and close-by metal objects, and is nearly as good a signal conductor as feeder cable, particularly for foam-type coaxial cables. Coaxial cable is somewhat more difficult to install at the point where the cable enters the building. If coaxial cable is selected, make sure the antenna is designed to be used with that type of cable.

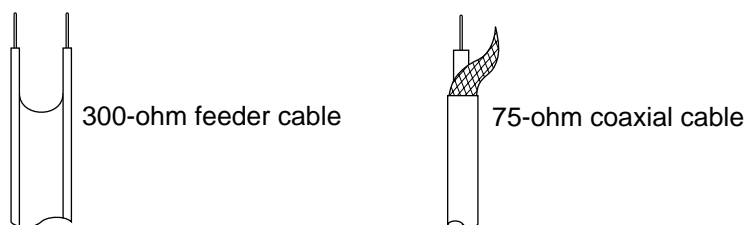

Use a 75-ohm/300-ohm antenna adapter (not included) or a 75-ohm antenna adapter (not included) for connections.

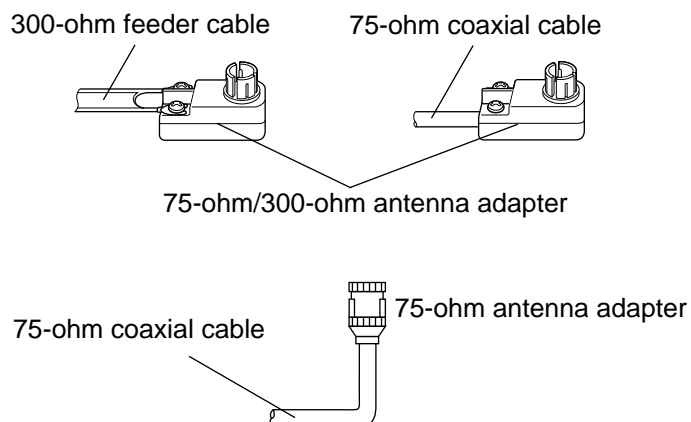

Notes for FM antenna installation

- To minimize automobile ignition noise, locate the antenna as far from heavy traffic as possible.
- Keep the feeder cable or coaxial cable as short as possible. Do not bundle or roll up excess cable.
- The antenna should be at least two meters (6.6 feet) from reinforced concrete walls or metal structures.

Optional outdoor AM antenna

In steel buildings or at a great distance from the transmitter, it may be necessary to install an outside long wire antenna.

GND terminal

For maximum safety and minimum interference, connect the GND terminal to a good earth ground. A good earth ground is a metal stake driven into moist earth.

CONNECTING SPEAKER SYSTEMS

Connect the SPEAKERS terminals to your speakers with wire of the proper gauge, cut as short as possible. If the connections are faulty, no sound will be heard from the speakers. Make sure that the polarity of the speaker wires is correct, that is, + and – markings are observed. If these wires are reversed, the sound will be unnatural and will lack bass. Do not let the bare speaker wires touch each other or any other metal part as this could damage this unit and/or speakers.

NOTE: Use speakers with the specified impedance shown on the rear of this unit.

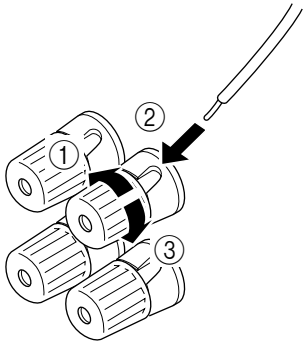

Red: positive (+)
Black: negative (-)

- ① Unscrew the knob.
- ② Insert the bare wire.
[Remove approx. 5mm (1/4")
insulation from the speaker
wires.]
- ③ Tighten the knob and
secure the wire.

NOTE: Banana Plug connections are also possible (except Singapore model). Simply insert the Banana Plug connector into the corresponding terminal.

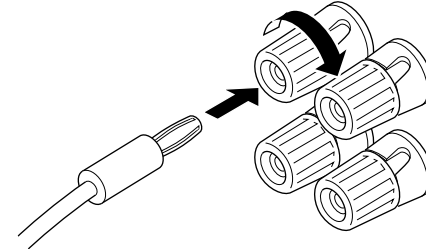

CONNECTING THE MAIN SPEAKERS TO THIS UNIT

One or two sets of MAIN speakers can be connected to this unit.

If you use two sets of MAIN speakers, connect one set to the MAIN SPEAKERS A terminals, and connect another set to the B terminals. If you use only one set of MAIN speakers, connect them to either the MAIN SPEAKERS A or B terminals. Make sure that the jumper bars between the PRE OUT and MAIN IN jacks on the rear panel are in place.

It is also possible to use an external power amplifier if more power is desired. In this case, remove the jumper bars and connect the PRE OUT jacks to the INPUT jacks of a stereo power amplifier with a stereo pin cable—making sure to connect the left and right channels correctly. Connect the MAIN speakers to the speaker output terminals of the power amplifier.

Set the SPEAKERS switch A or B (or both A and B) on the front panel corresponding to the main speakers you will use to the ON position. Set the switch for the main speakers you will not use to the OFF position. Selected main speakers are shown by the lighting of “SPEAKERS A” and/or “SPEAKERS B” on the display panel.

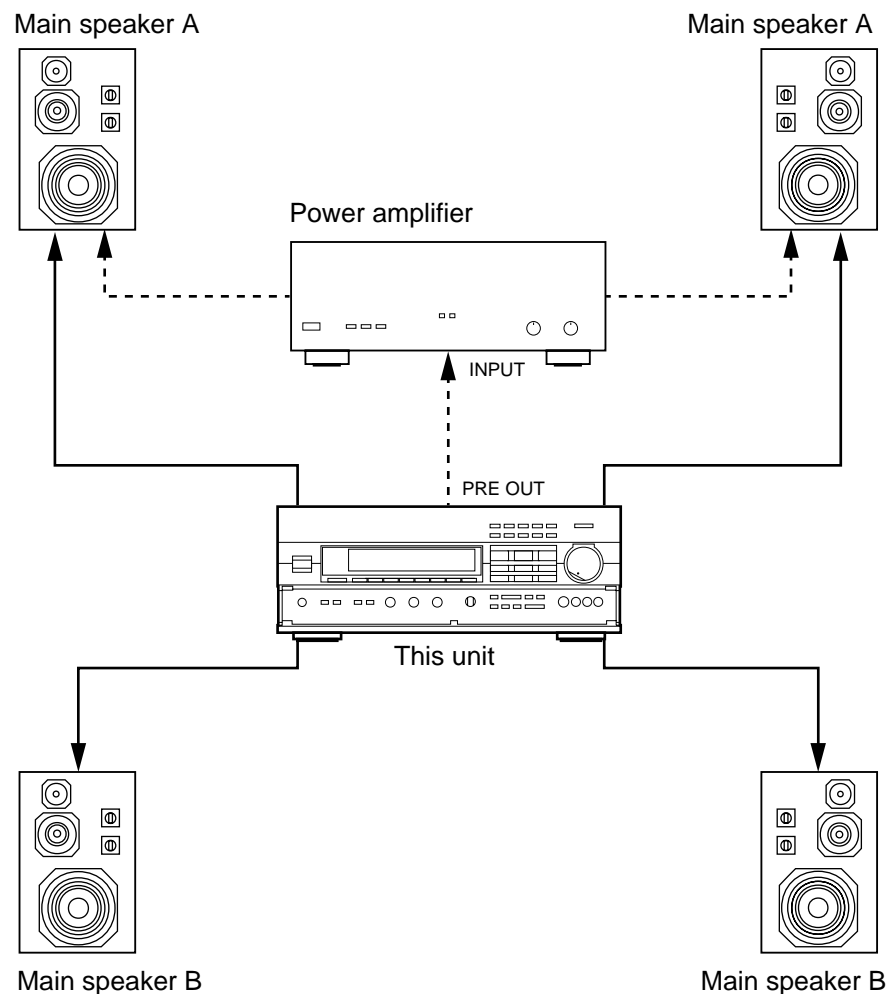

CONNECTING THE FRONT EFFECT SPEAKERS, REAR SPEAKERS AND THE CENTER SPEAKER(S) TO THIS UNIT

Connect the FRONT effect speakers to the FRONT EFFECT SPEAKERS terminals of this unit.

If the FRONT effect speakers are not used, the FRONT MIX switch should be set to "ON".

Connect the REAR speakers to the REAR SPEAKERS terminals of this unit.

Connect the CENTER speaker to the CENTER SPEAKERS terminals. If you will be using one CENTER speaker, connect it to either the C or D terminals and set the CENTER speaker switch so that it is released outward ("C OR D" position). If using two CENTER speakers, connect them to the C and D terminals, and press the switch inward ("C +D" position). If, however, you will not be using a CENTER speaker, be sure to set the CENTER SPEAKER mode to "PHNTM" (phantom). (See page 35.)

NOTE: The speaker connections above are fine for most applications. If for some reason, however, you wish to use an external power amp for any or all of the front effect, rear and center channels, connect the line level output jack(s) for each channel to the INPUT jacks of the external amp and connect the corresponding speaker pair to the speaker terminals of the external amp.

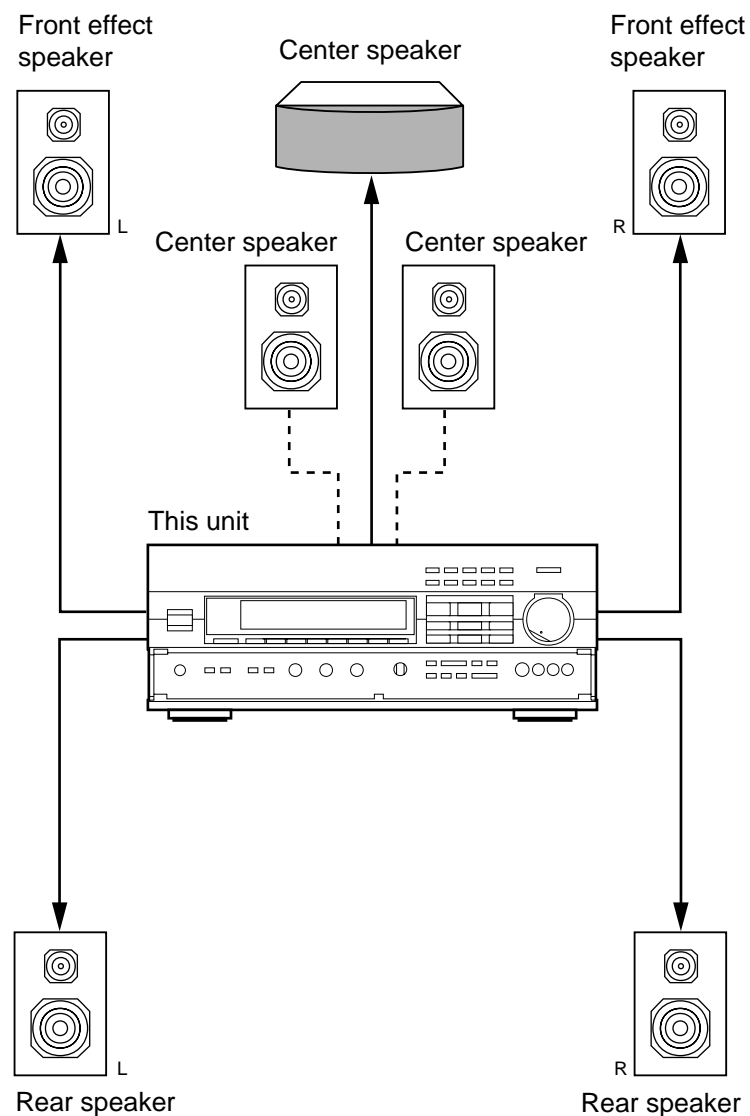

ADDING A SUBWOOFER

You may wish to add a subwoofer to reinforce the bass frequencies.

This unit provides line-level subwoofer outputs. If you use one subwoofer, connect either of the SUBWOOFER jacks to the INPUT jack of the subwoofer amplifier, and connect the speaker terminals of the subwoofer amplifier to the subwoofer.

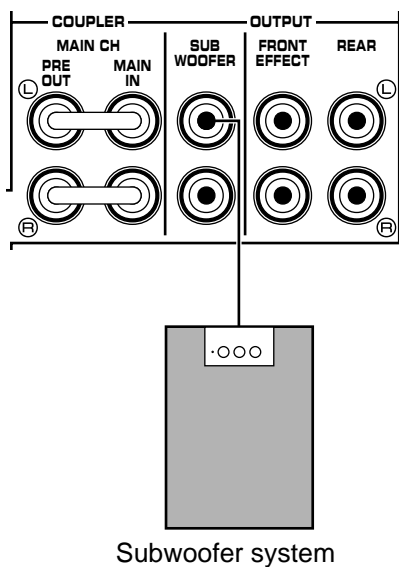

If you wish to obtain more presence in your listening room, the use of two subwoofers is recommended. To connect two subwoofers to this unit, connect one SUBWOOFER jack to the INPUT jack of the amplifier driving a subwoofer, and the other SUBWOOFER jack to the INPUT jack of the amplifier driving the other subwoofer, and then connect each subwoofer to the corresponding amplifier.

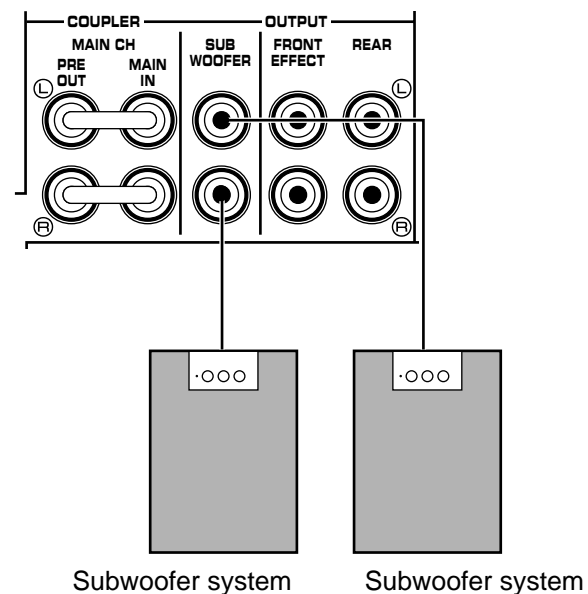

With some subwoofers, including the Yamaha Active Servo Processing Subwoofer System, the amplifier and subwoofer are in the same unit.

Switching the IMPEDANCE SELECTOR switch on the rear panel

Select the position whose requirements your speaker system meets. Be sure to switch this only when the power of this unit is turned off.

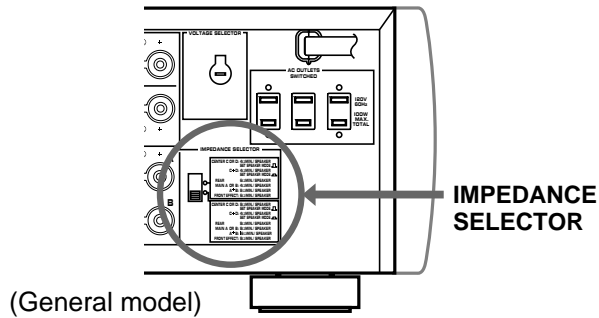

WARNING

Do not change the IMPEDANCE SELECTOR switch setting while the power to this unit is on, otherwise this unit may be damaged.

IF THIS UNIT FAILS TO TURN ON WHEN THE POWER SWITCH IS PRESSED

The IMPEDANCE SELECTOR switch may not be set to either end closely. If so, set the switch to either end closely.

 (Upper position)

Center: If you use one center speaker, the impedance of the speaker must be 4Ω or higher.

If you use two center speakers, the impedance of each speaker must be 4Ω or higher.

Rear: (U.S.A. and Canada models:)

The impedance of each speaker must be 4Ω or higher.

(Australia, Singapore and General models:)

The impedance of each speaker must be 6Ω or higher.

Main: If you use one pair of main speakers, the impedance of each speaker must be 4Ω or higher.

If you use two pairs of main speakers, the impedance of each speaker must be 8Ω or higher.

Front effect:

The impedance of each speaker must be 6Ω or higher.

 (Lower position)

Center: If you use one center speaker, the impedance of the speaker must be 8Ω or higher.

If you use two center speakers, the impedance of each speaker must be 4Ω or higher.

Rear: The impedance of each speaker must be 8Ω or higher.

Main: If you use one pair of main speakers, the impedance of each speaker must be 8Ω or higher.

(Except Canada model:)

If you use two pairs of main speakers, the impedance of each speaker must be 16Ω or higher.

Front effect:

The impedance of each speaker must be 8Ω or higher.

SELECTING THE OUTPUT MODES SUITABLE FOR YOUR SPEAKER SYSTEM

This unit provides you the following four functions to determine the method of distributing output signals to speakers suitable for your audio system. When speaker connections are all completed, select a proper position on each function to make the best use of your speaker system.

- 4. CENTER SPEAKER
- 5. REAR SPEAKER
- 6. MAIN SPEAKER
- 7. LFE/BASS OUT

DESCRIPTION OF EACH FUNCTION

4. CENTER SPEAKER

Choices: NRML/WIDE/PHNTM

Preset position: NRML

NRML (Normal):

Select this position when you use a center speaker that is smaller than the main speakers. In this position, low bass signals (below 90 Hz) at the center channel are output from the main speakers (or the SUBWOOFER jacks if the SMALL position is selected on "6. MAIN SPEAKER" and the SWFR position is selected on "7. LFE/BASS OUT").

WIDE: Select this position when your center speaker is approximately the same size as the main speakers.

PHNTM (Phantom):

Select this position when you do not have a center speaker. The center channel sound will be output from the left and right main speakers.

5. REAR SPEAKER

Choices: SMALL/LARGE

Preset position: SMALL

SMALL:

Select this position if your rear speakers do not have a high ability for bass reproduction.

In this position, low bass signals (below 90 Hz) at the rear channels are output from the SUBWOOFER jacks (or the main speakers if the MAIN position is selected on "7. LFE/BASS OUT").

LARGE:

Select this position if your rear speakers have a high ability for bass reproduction, or a subwoofer is connected to the rear speaker in parallel.

In this position, full range signals are output from the rear speakers.

6. MAIN SPEAKER

Choices: **SMALL/LARGE**

Preset position: **LARGE**

SMALL:

Select this position if your main speakers do not have a high ability for bass reproduction. However, if your system does not include a subwoofer, do not select this position. In this position, low bass signals (below 90 Hz) at the main channels are output from the SUBWOOFER jacks (if the SWFR or BOTH position is selected on "7. LFE/BASS OUT").

LARGE:

Select this position if your main speakers have a high ability for bass reproduction. In this position, full range signals present at the main channels are output from the main speakers.

7. LFE/BASS OUT

Choices: **MAIN/SWFR/BOTH**

Preset position: **SWFR**

MAIN: Select this position if your system does not include a subwoofer.

In this position, full range signals present at the main channels, signals from the LFE channel and other low bass signals that are selected on "4. CENTER SPEAKER" to "6. MAIN SPEAKER" to be distributed from other channels are output from the main speakers.

SWFR/BOTH:

Select either the SWFR or BOTH position if your system includes a subwoofer.

In either position, signals at LFE channel and other low bass signals that are selected on "4. CENTER SPEAKER" to "6. MAIN SPEAKER" to be distributed from other channels are output from the SUBWOOFER jacks. When the LARGE position is selected on "6. MAIN SPEAKER", in the **SWFR** position, no signal is distributed from the main channels to the SUBWOOFER jacks, however in the **BOTH** position, low bass signals from the main channels are output to both of the main speakers and the SUBWOOFER jacks.

METHOD OF CHANGING SELECTIONS

Operations should be made watching information on this unit's display panel or the monitor screen.

1. Turn the power of this unit on. (If you want to display information on the monitor, turn the power of the monitor on.)

Front panel

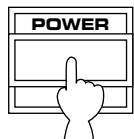

If you will use the remote control unit, set the TIME/LEVEL-SET MENU switch to the SET MENU position on the remote control unit.

NOTE: Be sure to use the remote control unit with the lid open.

Remote control



2. Press once or more until "4. CENTER SPEAKER" appears on the display.

Front panel



or

Remote control

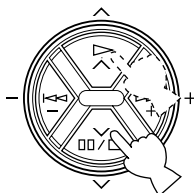

3. Press "+" or "-" once or more so that the arrow points the position you will select.

Front panel

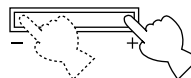

or

Remote control

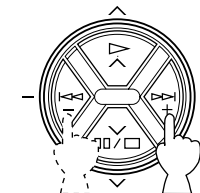

4. Press once or more until the title of another function on which you will change the selection appears on the display.

Front panel

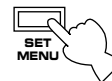

or

Remote control

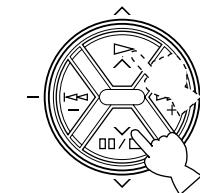

5. Press "+" or "-" once or more so that the arrow points the position you will select.

Front panel

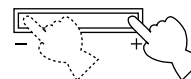

or

Remote control

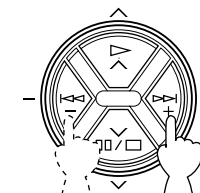

6. Repeat step 4 and 5 to change selections on other functions in the same way.

CONNECTING AND CONTROLLING ROOM 2 EQUIPMENT

You can make up a multi-room audio/video system with this unit. In this system, this unit and Yamaha audio/video units connected to this unit in the main room can be controlled by using the provided Room 2 remote control unit from the second room so that this unit sends audio and video signals (different from ones selected in the main room) to the amplifier, monitor TV, etc. in the second room.

CONNECTIONS

To use the multi-room functions of this unit, you need the following additional optional products:

- An infrared signal receiver for the second room
- An infrared emitter in the main room
This emitter transmits the infrared signals from the Room 2 remote control unit in the second room to the other components in the main room (for example, CD player or LD player).
- An amplifier and speakers for the second room
- A video monitor for the second room

NOTE

Since there are so many ways to connect and use this unit in a multi-room installation, we recommend that you consult with a custom installation specialist for the Room 2 connections which will best meet your requirements.

*¹:Some Yamaha models are able to connect directly to this unit via the REMOTE CONTROL OUT jacks. If you own these products, the use of an infrared emitter may not be necessary.

A Sample of system configuration and connections

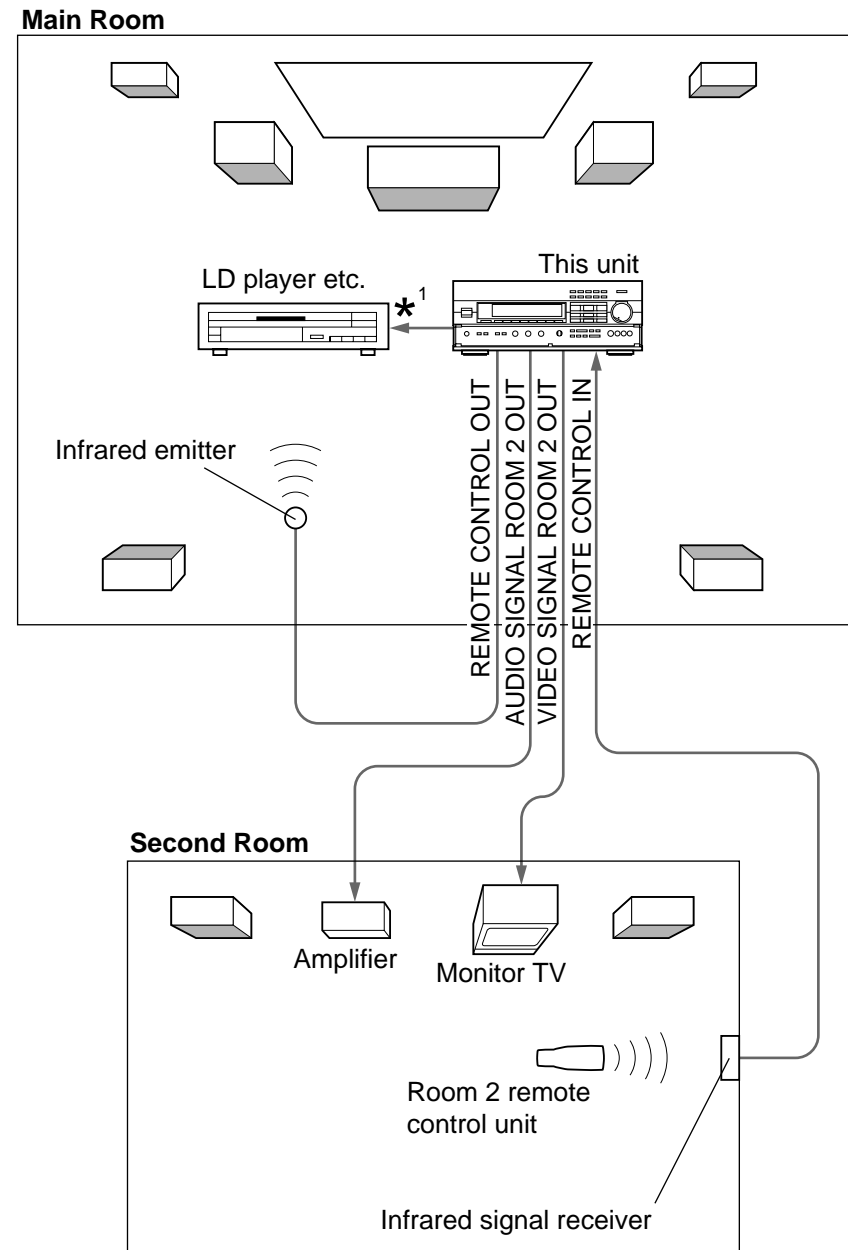

ROOM 2 REMOTE CONTROL UNIT

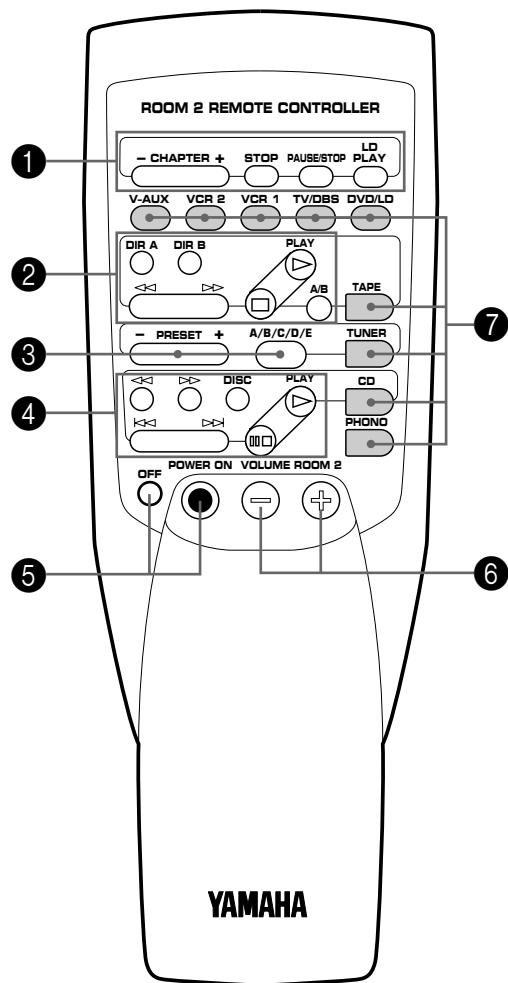

This remote control unit makes input source selections on this unit and controls Yamaha remote control-compatible CD player, tape deck, LD player and/or tuner connected to this unit for the second room independent of the input source selections for the main room.

NAMES OF KEYS AND THEIR FUNCTIONS

- 1** LD player keys
Controls LD player.
- 2** Tape deck keys
Controls tape deck.
 - * DIR A, B and A/B are applicable only to double cassette tape deck.
 - * For a single cassette deck with automatic reverse function, pressing DIR A will reverse the direction of tape running.
- 3** Tuner keys
Controls tuner.
 - + : Selects higher preset station number.
 - : Selects lower preset station number.
 - A/B/C/D/E : Selects the group (A – E) of preset station numbers.
- 4** CD player keys
Controls compact disc player.
 - * DISC is applicable only to compact disc changer.

5 POWER ON and OFF keys
(U.S.A. and Canada models)

Pressing the POWER ON key turns the power of this unit on and pressing the OFF key turns the power off.

(Except U.S.A. and Canada models)

While the power is on, pressing the OFF key switches the unit from the power-on mode to the standby mode, and pressing the POWER ON key switches the unit from the standby mode to the power-on mode. (In the standby mode, the standby indicator on the front panel is illuminated.)

6 VOLUME ROOM 2 + (up) and – (down) keys

Increase or decrease the output level of signals sent to the amplifier in the second room only.

7 Input selector keys
Selects input source.

Note on using the remote control units

If you use the Room 2 remote control unit (for the second room) in the main room, the input selector keys of this remote control unit affect the settings in the second room, not the main room. The other keys on the remote control unit work the same in both the main room and the second room.

Display panel information

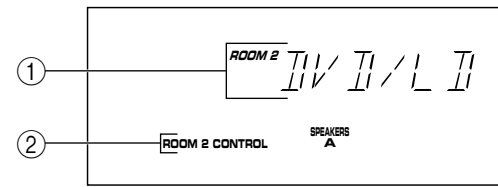

- ① Lights up when you switch the input source for the second room by using the Room 2 remote control unit in the main room. The name of selected source also lights up.
- ② Lights up momentarily when the Room 2 remote control unit is used in the second room.

CAUTION

In some cases, adjustments made using the Room 2 remote control unit may not be evident on this unit. For example, if both the main room and second room are set to the tuner, it is possible for the person in the second room to change the station. This may be a problem, especially when you are taping a source without directly monitoring it.

SPEAKER BALANCE ADJUSTMENT

This operation uses an internal test-tone generator for balancing the levels of the main, center, rear and front effect speakers.

The adjustment of each speaker output level should be done at your listening position with the remote control unit. Otherwise, the result may not be satisfactory.

NOTE: Be sure to use the remote control unit with the lid open.

1. Set the TIME/LEVEL-SET MENU switch on the remote control to the TIME/LEVEL position.

Remote control



2. Depress the TEST key on the remote control so that "TEST DOLBY SUR." appears on the display panel to enter test mode. A hiss-like calibration signal should be heard from the left main speaker, center speaker(s), right main speaker, right rear speaker and left rear speaker in turn (see diagram). Adjust the master VOLUME to a normal listening level.

Remote control



* The state of test-tone output is shown on the display panel and the monitor screen. (On the monitor screen, it is shown by an image of audio listening room.) This is convenient for adjusting each speaker level.

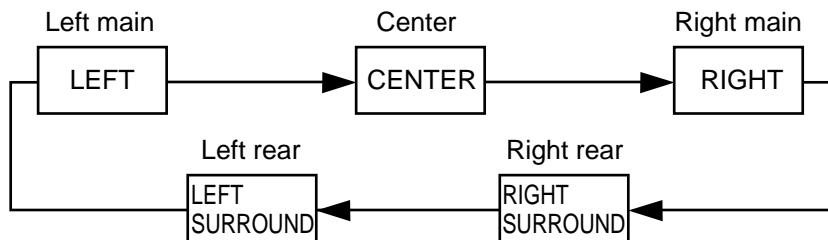

3. Press the ^ or v key to select the speaker whose level you will adjust.

Remote control

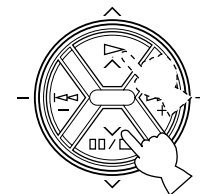

* Whenever the v key is pressed, the speaker selection changes in turn as follows.

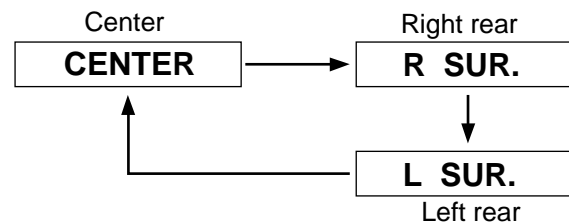

Pressing the ^ key changes the speaker in the reverse order.

* If the CENTER SPEAKER mode is set to "PHNTM" (phantom), "CENTER" cannot be selected. (See page 35.)

4. Adjust the level of the speaker selected in step 3 by pressing the + or - key so that it becomes almost as same as that of the main speakers.

* While adjusting, the test-tone is fixed on the selected speaker.

Remote control

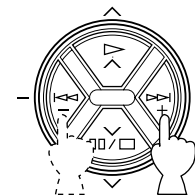

5. Repeat step 3 and 4 to adjust the level of other speakers.

NOTE: If there is insufficient volume from the effect speakers, you may decrease the main speaker volume level by setting the MAIN LEVEL switch on the rear panel to “-10 dB”, and adjust each speaker level again. Volume controls on external power amplifiers may also be adjusted if necessary to achieve proper balance.

NOTE: If not using a center speaker, be sure to set the “4. CENTER SPEAKER” in the SET MENU mode to the PHNTM (phantom) position. You will then hear the center channel test tone from the left and right main speakers.

6. For the front effect speaker level adjustment, depress the TEST key on the remote control again so that “TEST DSP” appears on the display panel. A calibration signal should be heard from the main speakers and the front effect speakers in turn (see diagram).

Remote control

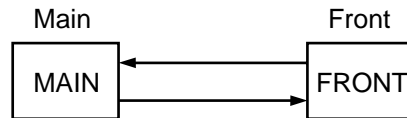

* If the FRONT MIX switch on the rear panel is set to “ON (5ch)”, the front effect speaker level cannot be adjusted by this method.

7. Adjust the front effect speaker level by pressing the + or – key so that it becomes almost as same as that of the main speakers.

* While adjusting, the test-tone is fixed on the front effect speaker.

Remote control

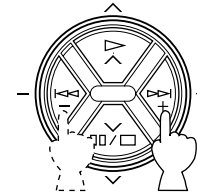

8. When this adjustment is finished, press the TEST key once again.

Remote control



NOTE: Once you have completed these adjustments, use only VOLUME control of this unit or MASTER VOLUME keys of the remote control unit to adjust the whole listening volume. Do not change any other volume setting in the system.

ADJUSTMENTS IN THE “SET MENU” MODE

The following eight types of functions maximize the performance of your system and expand your enjoyment for audio listening and video watching.

1. CENTER DELAY
2. DYNAMIC RANGE
3. LFE LEVEL
4. CENTER SPEAKER
5. REAR SPEAKER
6. MAIN SPEAKER
7. LFE/BASS OUT
8. INPUT MODE (TV/DBS)

METHOD OF SETTING CHANGE AND ADJUSTMENT

Operations should be made watching information on this unit's display panel or the monitor screen. If you want to display information on the monitor, turn the power of the monitor on.

1. If you will use the remote control unit, set the TIME/LEVEL-SET MENU switch to the SET MENU position on the remote control unit.

NOTE: Be sure to use the remote control unit with the lid open.

Remote control



2. Select the function (title) on which you will make a change.

Front panel

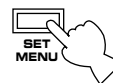

or

Remote control

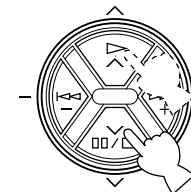

3. Select any desired position or edit parameters on the function.

Front panel

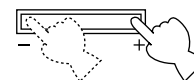

or

Remote control

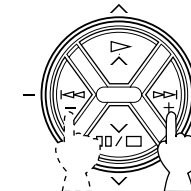

In the same way, make a setting change or adjustment on any other function.

DESCRIPTIONS OF THE FUNCTIONS

1. CENTER DELAY (Adjusting the delay of center sounds (dialog etc.))

Control range: 0 ms to 5 ms (in 1 ms step)

Preset value: 0 ms

- * This adjustment is effective only when the Dolby Digital (AC-3) is decoded and the signals of selected source encoded with the Dolby Digital (AC-3) contain center-channel signals.

Adjusts the delay between the main sounds (at the main channels) and dialog etc. (at the center channel).

The larger the value, the later the dialog etc. is generated.

This is for making sounds from the left main, center and right main speakers reach your listening position at the same time by delaying the sound from the center speaker if the distance from the center speaker to your listening position is shorter than the distance from the left or right main speaker to your listening position.

2. DYNAMIC RANGE (Adjusting dynamic range)

Choices: MAX/STD/MIN

Preset position: MAX

- * This adjustment is effective only when the Dolby Digital (AC-3) is decoded.

MAX: “Dynamic range” is the difference between the maximum level and the minimum level of sounds. Sounds on a movie originally designed for movie theaters feature very wide dynamic range.

Dolby Digital (AC-3) technology can bring the original sound track into a home audio format with this wide dynamic range unchanged.

In this position, a source encoded with the Dolby Digital (AC-3) is reproduced in the original sound track’s wide dynamic range providing you with powerful sounds like a movie theater.

Selecting this position will be more ideal if you can listen to a source in a high output level in a room specially soundproofed for audio/video enjoyment.

STD (Standard):

Powerful sounds of extremely wide dynamic range are not always suitable for home use. Depending upon the condition of your listening environment, it may not possible to increase the sound output level as high as a movie theater, however, in a level proper for listening to in your room, the low level parts of source sound cannot be heard as well because they will be lost among noises in your environment.

Dolby Digital (AC-3) technology also makes it possible to reduce an original sound track’s dynamic range for a home audio format by “compressing” the data.

In this position, a source encoded with the Dolby Digital (AC-3) is reproduced in the “compressed” dynamic range of the source suitable for low level listening.

MIN: In this position, dynamic range is more reduced than in the STD position. Selecting this position will be effective when you must listen to a source in extremely low level.

3. LFE LEVEL (Adjusting the output level at the LFE (low frequency effect) channel)

Control range: –20 dB to 0 dB (in 1 dB step)

Preset value: 0 dB

- * This adjustment is effective only when the Dolby Digital (AC-3) is decoded and the signals of selected source encoded with the Dolby Digital (AC-3) contain LFE signals.

Adjusts the output level at the LFE (low frequency effect) channel. If the LFE signals are mixed with signals at other channels to output them from the same speakers, the ratio of LFE signal level to the level of other signals are adjusted. (See page 6 for details about the LFE channel.)

4. CENTER SPEAKER

5. REAR SPEAKER

6. MAIN SPEAKER

7. LFE/BASS OUT

See pages 35 to 37 for details. (Once you have selected proper modes, you do not have to make a setting change until any alteration is made in your speaker system.)

8. INPUT MODE (Selecting the initial input mode of the sources connected to the TV/DBS input jacks)

For the sources connected to the TV/DBS input jacks of this unit only, you can designate the input mode that is automatically selected when the power of this unit is switched on.

AUTO: In this position, the AUTO input mode is always selected when the power of this unit is switched on.

LAST: In this position, the input mode you have selected last time is memorized and will not be changed even if the power of this unit is switched on.

- * See page 47 for details about switching the input mode.

GENERAL OPERATION

PLAYING A SOURCE

NOTE: If you will use the remote control unit, be sure to use it with the lid open.

1. Set the master VOLUME control to minimum.

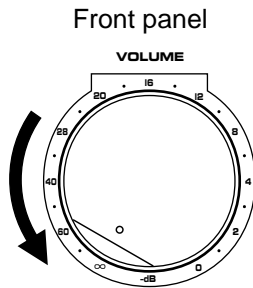

2. Turn the power on.

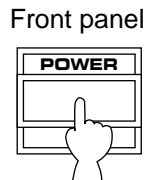

3. Select an input source.

The selected source is shown by the display panel and the monitor screen. For the DVD/LD or TV/DBS source, its current input mode is also shown.

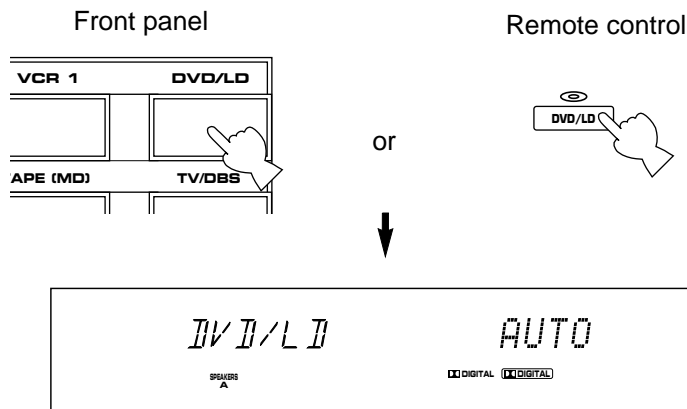

- * To change the input mode for the DVD/LD or TV/DBS source, press the input selector button for the currently selected source once or more until the desired input mode (AUTO or ANALOG) is shown on the display panel. (See page 47 for details on switching the input mode.)

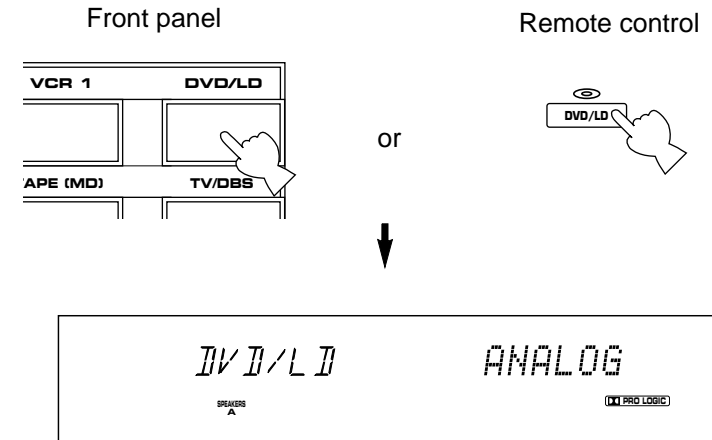

4. Play the source. (For detailed information on tuning operations, refer to page 50.)

5. Increase the setting of the master VOLUME control to your listening level.

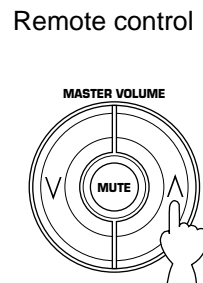
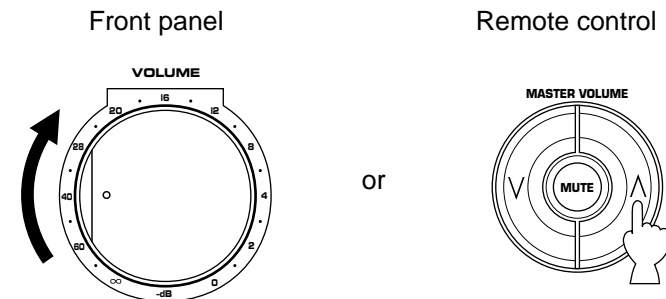

Adjust the BASS, TREBLE, BALANCE controls, etc., or select a desired sound field program. (See page 54.)

Notes on using the input selector buttons

- Note that pressing on each input selector button selects the source which is connected to the corresponding input terminals on the rear panel.
 - * To select the source connected to the VIDEO AUX terminals on the front panel, press VIDEO AUX.
- Once you play a video source, its video image will not be interrupted even if the input selector button for an audio source is selected.
- When you select an input source by pressing the corresponding input selector button, the DSP program (or the state of no DSP program is used) which was used when the same input source was selected the last time will automatically recalled.

Switching the input mode (for DVD/LD and TV/DBS)

This unit allows you to switch the input mode only for sources connected to the DVD/LD and TV/DBS input jacks (on the rear of this unit) that input two or three types of signals to this unit.

The following two input modes are provided.

AUTO: For the source connected to the DVD/LD input jacks:

This mode is automatically selected when you turn on the power of this unit. In this mode, input signal is automatically selected by the following order of priority.

1. Digital input signal from the OPTICAL jack
2. Digital input signal from the COAXIAL jack
3. Analog input signal

For the source connected to the TV/DBS input jacks:

This mode is automatically selected when you turn on the power of this unit if the "AUTO" position is selected on "8. INPUT MODE" in the SET MENU mode. (See page 45 for details.) In this mode, input signal is automatically selected by the following order of priority.

1. Digital input signal from the COAXIAL jack
2. Analog input signal

ANALOG:

In this mode, only analog input signal is selected even though digital signal is input at the same time.

Select this mode when you want to use the analog input signal instead of the digital input signal.

NOTE: For the TV/DBS source only, the input mode selected on the function "8. INPUT MODE" in the SET MENU mode is selected when you turn on the power of this unit.

Notes on input mode selection

- To play back a source with the Dolby Digital (AC-3) decoded, set the input mode to "AUTO".
- When you want to enjoy a source which has normal 2-channel signals with a Dolby Pro Logic Surround program, select the ANALOG mode.
- In the AUTO mode, there may be a case depending on some LD players or DVD players that when you make a search on a source encoded with the Dolby Digital (AC-3) during the play and then the play is restored, sound output is interrupted for a moment because the digital input signal is selected again.

RECORDING A SOURCE TO AUDIO/VIDEO TAPE (OR DUBBING FROM A TAPE TO ANOTHER)

NOTE: If you will use the remote control unit, be sure to use it with the lid open.

1. Set the REC OUT selector to the SOURCE position.

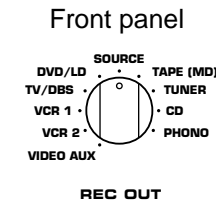

2. Select the source you want to record.

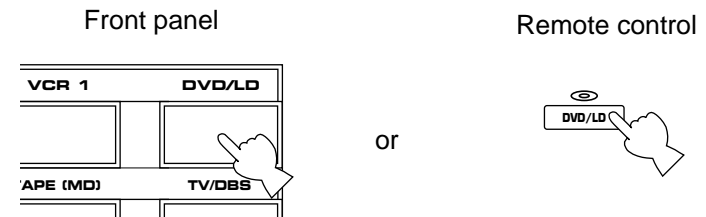

3. Play the source and increase the setting of the master VOLUME control to confirm it. (For detailed information on tuning operations, refer to page 50.)

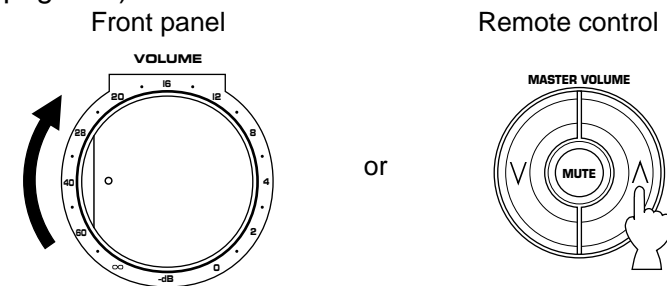

4. Set the tape deck, MD recorder or VCR used for recording to the recording mode.

Regardless of the setting of input selector buttons, when you set the REC OUT selector to a position other than "SOURCE", the source selected by the REC OUT selector can be recorded by other tape deck (MD recorder) and/or VCRs connected to this unit.

While recording a source by setting the REC OUT selector to the position other than SOURCE as described above, the following operations can be made at the same time.

- You can monitor the audio (or the audio and video) signals being recorded by selecting the recording unit (TAPE (MD), VCR 1 or VCR 2) with the corresponding input selector button.
- You can watch or listen to any other source by selecting it with the corresponding input selector button.

NOTE: Adjusting the master VOLUME, BASS, TREBLE controls, etc., or selecting a sound field program has no effect on the material being recorded.

NOTE: Composite video and S video signals pass independently through this unit's video circuits. Therefore, when recording or dubbing video signals, if your video source unit is connected to provide only a S video (or only a composite video) signal, you can record only a S video (or only a composite video) signal on your VCR.

NOTE: A source that is connected to this unit between digital jacks only cannot be recorded by a tape deck or VCR connected to this unit.

NOTE: Please check the copyright laws in your country to record from records, compact discs, radio, etc. Recording of copyright material may infringe copyright laws.

If you watch a video software that uses scramble or encoded signals to prevent it from being dubbed, there may be a case that display information superimposed on the picture and/or the picture itself is disturbed due to those signals.

TUNING OPERATIONS

Normally, if station signals are strong and there is no interference, quick automatic-search tuning (AUTOMATIC TUNING) is possible. However, if signals of the station you want to select are weak, you must tune to it manually (MANUAL TUNING).

AUTOMATIC TUNING

1. Select "TUNER" as the input source.

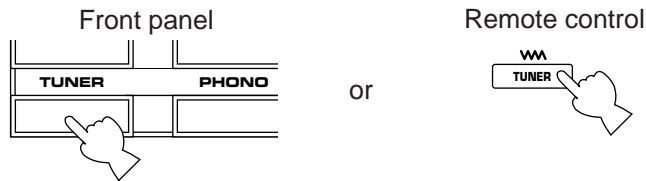

2. Select the reception band (FM or AM) confirming it on the display panel.

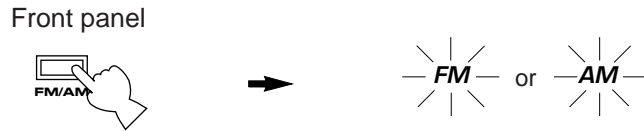

3. If "AUTO TUNING" is not illuminated on the display panel, press once so that it lights up.

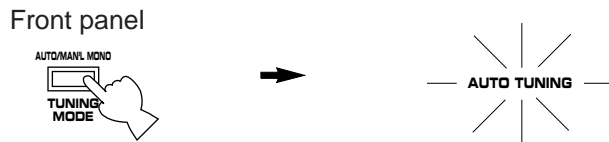

4. Begin the automatic tuning search.
To tune to a higher frequency, press the right side once.
To tune to a lower frequency, press the left side once.

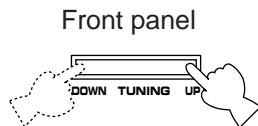

- If the station where tuning search stops is not the desired one, press again.
- If the tuning search does not stop at the desired station (because the signals of the station are weak), change to the MANUAL TUNING method.

MANUAL TUNING

1. Select "TUNER" as the input source.

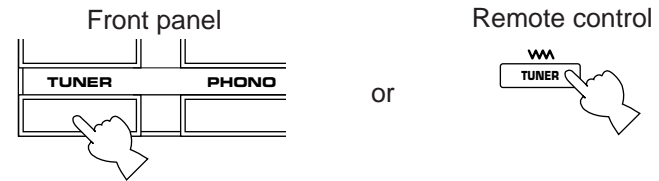

2. Select the reception band (FM or AM) confirming it on the display panel.

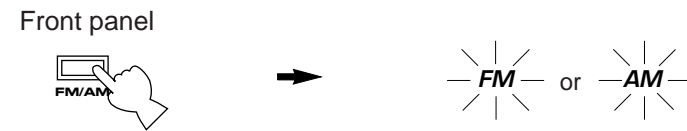

3. If "AUTO TUNING" is illuminated on the display panel, press once so that it goes off.

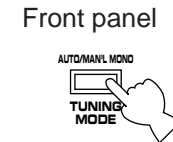

4. Tune to a desired station manually.
To continue tuning search, press and hold the button.

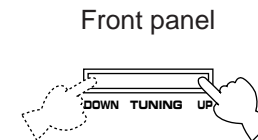

NOTE

If you tune to an FM station manually, it is received in monaural mode automatically to increase the signal quality.

PRESET TUNING

MANUAL PRESET TUNING

This unit can store station frequencies selected by tuning operation. With this function, you can recall any desired station by only selecting the preset station number where it is stored. Up to 40 stations (8 stations x 5 groups) can be stored.

To store stations

1. Tune to a desired station.
(Refer to the previous page for tuning procedure.)
2. Select a desired group (A – E) of preset stations confirming it on the display panel.

Front panel

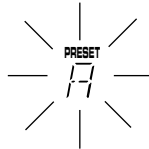

Press once or more.

3. Press the MEMORY button.

Front panel



Flashes on and off for about 5 seconds.

4. Select a preset station number where you want to program the station before "MEMORY" goes off from the display.

Front panel

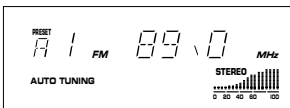
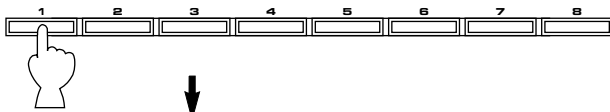

Shows the displayed station has been programmed to A1.

- In the same way, program other stations to A2, A3 ... A8.
- You can program more stations to preset station numbers on other groups in the same way by selecting other groups in step 2.

To recall a preset station

1. Select the group of preset stations.

Front panel

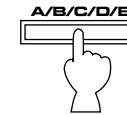

Press once or more.

2. Select the preset station number.

Front panel

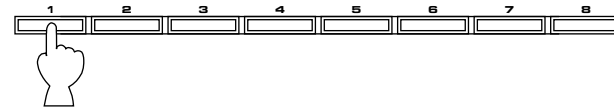

NOTES

- A new setting can be programmed in place of the former one.
- For presets, the setting of the reception mode (stereo or monaural) is stored along with the station frequency.

Memory back-up

The memory back-up circuit prevents the programmed data from being lost even if the POWER switch is set off or the power plug is disconnected from the AC outlet or the power is cut due to temporary power failure. If, however, the power is cut for more than one week, the memory may be erased. If so, it can be re-programmed by simply following the PRESET TUNING steps.

AUTOMATIC PRESET TUNING

You can also make use of an automatic preset tuning function for FM stations only. By this function, this unit performs automatic tuning and stores FM stations with strong signals sequentially. Up to 40 stations are stored automatically in the same way as in the manual preset tuning method on page 51.

To store stations

1. Select the FM band.

Front panel



2. Press and hold the MEMORY button for about 3 seconds.

Front panel

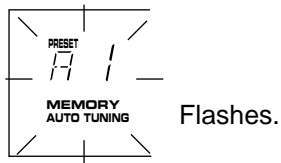

Flashes.

3. To tune to higher frequencies, press right side once.
To tune to lower frequencies, press left side once.

Front panel

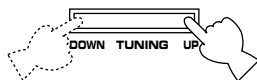

- * If the TUNING button is not pressed, in a while, the automatic preset tuning begins automatically toward higher frequencies.

The automatic preset tuning begins from the frequency currently displayed. Received stations are programmed to A1, A2 ... A8 sequentially.

- * If more than 8 stations are received, they are also programmed to the preset station numbers on other groups (B, C, D and E) in that order.

If you want to store the first station received by the automatic preset tuning to a desired preset station number.

If, for example, you want to store the first received station to C5, select "C5" by using the A/B/C/D/E switch and the preset station number selector buttons after pressing the MEMORY button in step 2. Then press the TUNING button. The first received station is stored to C5, and next stations to C6, C7 ... sequentially. If stations are stored up to E8, the automatic preset tuning is finished automatically.

When the automatic preset tuning is finished

The display shows the frequency of the last preset station. Check the contents and the number of preset stations by following the procedure of the section "To recall a preset station" on page 51.

To recall a preset station

Simply follow the procedure of the section "To recall a preset station" on page 51.

NOTES

- You can replace a preset station by another FM or AM station manually by simply following the procedure of the section “To store stations” on page 51.
- If the number of received stations is not enough to be stored up to E8, the search is finished automatically after searching all frequencies.
- With this function, only FM stations with sufficient signal strength are stored automatically. If the station you want to program is weak in signal strength, tune in to it with the MANUAL TUNING method (in monaural) and program it by following the procedure of the section “To store stations” on page 51.

EXCHANGING PRESET STATIONS

You can exchange the places of two preset stations with each other as shown below.

Example)

If you want to shift the preset station on E1 to A5, and vice versa.

1. Recall the preset station on E1 (by following the method of “To recall a preset station” on page 51).

2. Press the EDIT button.

Front panel

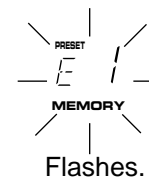

3. Next, recall the preset station on A5 by following the same method with step 1.



4. Press the EDIT button.

Front panel

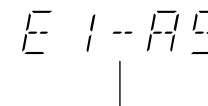

Shows the exchange of stations is completed.

SELECTING SOUND FIELD PROGRAMS

This unit has 10 programs for digital sound field processing, 6 from actual acoustic environments from around the world, and 4 programs for Audio/Video sources including sources encoded with Dolby Pro Logic surround or Dolby Digital (AC-3).

To select a DSP program

Simply pressing a DSP program selector button on the front panel or a DSP program selector key on the remote control unit turns on the digital sound field processor and select the corresponding program directly. The name of selected program lights up on the display panel and the monitor screen.

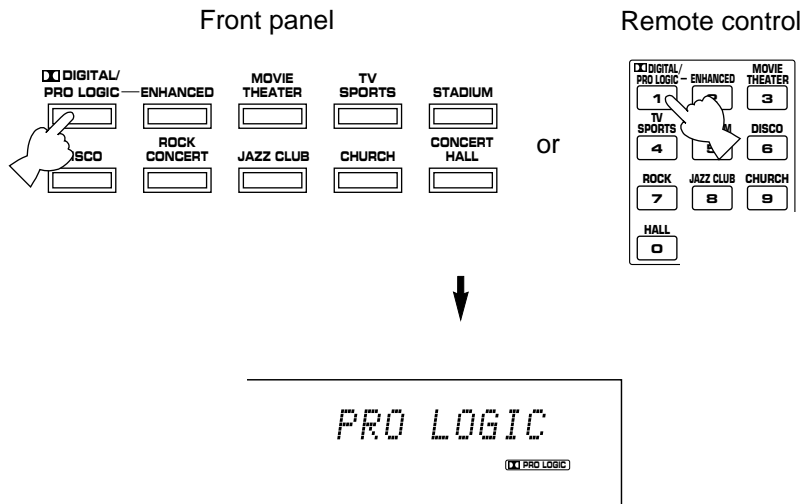

To enjoy a video source with the Dolby Pro Logic Surround or Dolby Digital (AC-3) decoded

When you select the program No. 1, 2 or 3, and the input signal of the source is 2-channel stereo, Dolby Pro Logic Surround is decoded. When some program is selected and the input signal of the source is encoded with the Dolby Digital (AC-3), Dolby Digital (AC-3) is automatically decoded.

- The following indicators on the display panel show you what sound processing is being made.

Lights up when the Dolby Digital (AC-3) is being decoded and the signals of selected source encoded with the Dolby Digital (AC-3) is not in 2-channels.

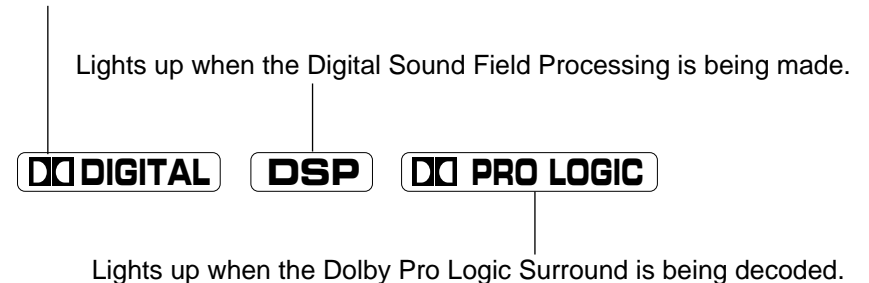

- In addition, for the program No. 1, 2 and 3, the name of the program on the display panel or the monitor screen will change according to the type of decoding. (See pages 56–57 for details.)

NOTE: If the input signals of source encoded with the Dolby Digital (AC-3) are in 2-channels only, the sound processing for them is similar to that for analog or PCM audio signals.

CANCELING THE EFFECT SOUND

The EFFECT switch on the front panel and the EFFECT ON/OFF key on the remote control unit make it simple to compare the normal stereo sound with the fully processed effect sound.

To cancel the effect sound and monitor only the main sound, press the EFFECT ON/OFF key or the EFFECT switch. Press the EFFECT ON/OFF key or the EFFECT switch a second time to restore normal operation.

Front panel

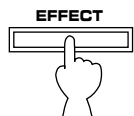

or

Remote control

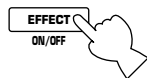

NOTES

- If the effect sound is canceled when signals encoded with the Dolby Digital (AC-3) are input to this unit, signals of all channels are mixed and are output from the main speakers.
- If the EFFECT switch or the EFFECT ON/OFF key is pressed to turn effect sounds OFF when the Dolby Digital (AC-3) is decoded, it may happen that sound is output faintly or not output normally depending on a source. In that case, press the EFFECT switch or the EFFECT ON/OFF key to turn effect sounds ON, or use input signals not encoded with the Dolby Digital (AC-3).

DESCRIPTIONS OF THE SOUND FIELD PROGRAMS

The following list gives brief descriptions of the sound fields produced by each of the DSP programs. Keep in mind that most of these are precise digital recreations of actual acoustic environments. The data for them was recorded at the locations described using sophisticated sound field measurement equipment.

* **The channel level balance between the left rear speaker and the right rear speaker may vary depending on the sound field you are listening to. This is due to the fact that most of these sound field recreations are actual acoustic environments.**

1. DOLBY PRO LOGIC

When the input signal is analog or PCM audio ()

Speaker output: main, center, rear

DOLBY DIGITAL

When the input signal is Dolby Digital ()

Speaker output: main, center, rear

Reproduces video discs, video tapes and similar sources which are Dolby Surround encoded and bear the "DOLBY SURROUND" logo.

The built-in Dolby Pro Logic Surround decoder or Dolby Digital (AC-3) decoder precisely reproduces sounds and sound effects of a source encoded with Dolby Surround. The realization of a highly efficient decoding process improves crosstalk and channel separation and makes sound positioning smoother and more precise.

2. DOLBY PRO LOGIC ENHANCED

When the input signal is analog or PCM audio ()

Speaker output: main, center, rear, front effect

DOLBY DIGITAL ENHANCED

When the input signal is Dolby Digital ( )



Speaker output: main, center, rear, front effect

Reproduces video discs, video tapes and similar sources which are Dolby Surround encoded and bear the "DOLBY SURROUND" logo.

This program ideally simulates the multi-surround speaker systems of the 35 mm film theater. The Dolby Surround decoding and the digital sound field processing is precisely performed without altering the originally designed sound orientation. The surround effects produced by this sound field folds the viewer naturally from the rear to the left and right and toward the screen.

NOTE: If the main channel sound is considerably altered by overadjustment of the BASS or TREBLE controls, the relationship with the rear channels may produce an unnatural effect.

3. MOVIE THEATER

When the input signal is analog or PCM audio ( )

Speaker output: main, center, rear, front effect

DIGITAL MOVIE THEATER

When the input signal is Dolby Digital ( )

Speaker output: main, center, rear, front effect

Ideal for reproducing video discs, video tapes and similar sources which are Dolby Surround encoded and bear the "DOLBY SURROUND" logo.

This program is ideal for precisely reproducing the sound design of the newest 70 mm/Dolby Digital multi-track films. The sound field is made to be similar to that of the newest movie theaters, so the reverberations of the sound field itself are restrained as much as possible. The three dimensional feeling of the sound field is emphasized, and dialog is precisely oriented on the screen. You can enjoy watching Sci-Fi, adventure movies, etc. with much presence.

4. TV SPORTS

When the input signal is analog or PCM audio ()

Speaker output: main, center, rear, front effect

When the input signal is Dolby Digital ( )

Speaker output: main, center, rear, front effect

This program is furnished with a tight sound field in which the sound will not spread excessively on the front side, but the rear surround side produces a dynamic sound expansion. This program is the most suitable for sports programs.

5. STADIUM

When the input signal is analog or PCM audio ()

Speaker output: main, rear, front effect

When the input signal is Dolby Digital ( )

Speaker output: main, center, rear, front effect

This program gives you long delays between direct sounds and effect sounds, and extraordinarily spacious feel of a large stadium.

6. DISCO

When the input signal is analog or PCM audio ()

Speaker output: main, rear, front effect

When the input signal is Dolby Digital ( )

Speaker output: main, center, rear, front effect

This program recreates the acoustic environment of a lively disco in the heart of a very lively city. The sound is dense and highly concentrated. It is also characterized by a high-energy, "immediate" sound.

7. ROCK CONCERT

When the input signal is analog or PCM audio ()

Speaker output: main, rear, front effect

When the input signal is Dolby Digital ( )

Speaker output: main, center, rear, front effect

This program is ideally suited for rock music. You will experience a very dynamic or lively sound field.

9. CHURCH

When the input signal is analog or PCM audio ()

Speaker output: main, rear, front effect

When the input signal is Dolby Digital ( )

Speaker output: main, center, rear, front effect

This program recreates the acoustic environment of a big church with a high pointed dome and columns along the sides. This interior produces very long reverberations.

8. JAZZ CLUB

When the input signal is analog or PCM audio ()

Speaker output: main, rear, front effect

When the input signal is Dolby Digital ( )

Speaker output: main, center, rear, front effect

This is a small, cozy jazz club with a low ceiling. The sound is very close and intimate.

10. CONCERT HALL

When the input signal is analog or PCM audio ()

Speaker output: main, rear, front effect

When the input signal is Dolby Digital ( )

Speaker output: main, center, rear, front effect

In this program, the center will appear to be deep behind the main speakers, creating an expansive large hall ambience. Orchestra and opera music are suited for this sound field.

NOTE: If the FRONT MIX switch on the rear panel is set to the "ON (5ch)" position, no sound is output from the front effect speakers, no matter what program is selected. Besides, if the "PHNTM" position is selected on "4. CENTER SPEAKER" in the SET MENU mode, no sound is output from the center speaker(s).

ADJUSTING DELAY TIME AND EACH SPEAKER OUTPUT LEVEL

In using the digital sound field processor including the Dolby Pro Logic Decoder or the Dolby Digital (AC-3) Decoder, you can adjust delay time between the main sound and effect sound, and each speaker output level as you prefer.

NOTE: These adjustments can be made only when the effect sound is on. If **DSP** and/or **DIGITAL** (or **PRO LOGIC**) is not illuminated on the display panel, press the EFFECT switch on the front panel or the EFFECT ON/OFF key on the remote control unit so that at least one of those indicators lights up on the display panel.

1. If you will use the remote control unit, set the TIME/LEVEL-SET MENU switch to the TIME/LEVEL position on the remote control unit.

NOTE: Be sure to use the remote control unit with the lid open.

Remote control



2. Press once or more until the name of item on which you will make an adjustment appears on the display panel.

Front panel

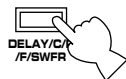

or

Remote control

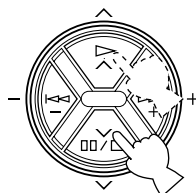

Whenever pressed, the selection changes as follows.

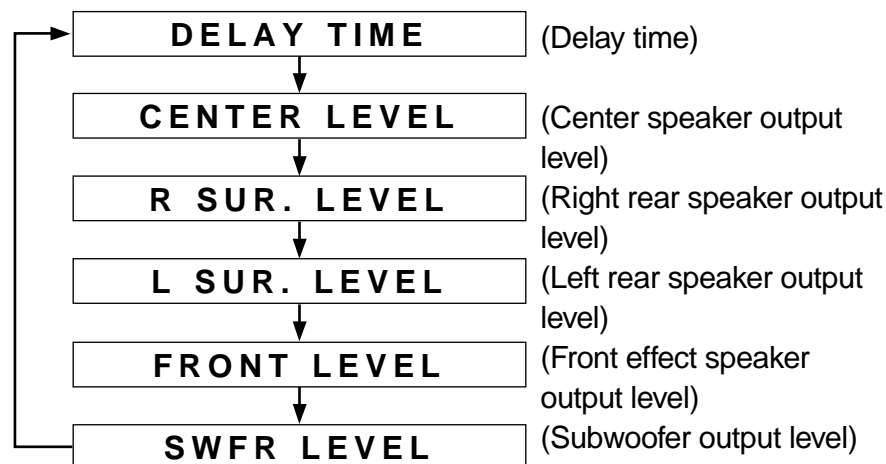

* Depending on a mode of this unit, the number of selections is reduced.

* Pressing the \wedge key on the remote control unit changes the selection in the reverse order.

3. Adjust its level.

Front panel

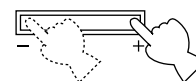

or

Remote control

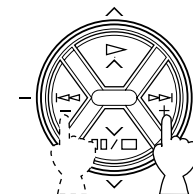

4. Repeat step 2 and 3 to make adjustments on other items.

Adjusting delay time

You can adjust the time difference between the beginning of the sound from the main speakers and the beginning of the effect sound from the rear or front effect speakers.

The larger the value, the later the effect sound is generated.

This adjustment can be made to all programs individually.

Program	Control range (ms)
1. DOLBY PRO LOGIC	15 to 30
DOLBY DIGITAL	0 to 15
2. PRO LOGIC ENHANCED	15 to 30
DOLBY DIGITAL ENHANCED	0 to 15
3. MOVIE THEATER	15 to 30
DIGITAL MOVIE THEATER	1 to 50
4. TV SPORTS	1 to 50
5. STADIUM	1 to 50
6. DISCO	1 to 50
7. ROCK CONCERT	1 to 50
8. JAZZ CLUB	1 to 50
9. CHURCH	1 to 50
10. CONCERT HALL	1 to 50

NOTES

- Adding too much delay will cause an unnatural effect with some sources.
- When the $-/+$ button is pressed, sound is momentarily interrupted.

Adjusting output level of the front effect, center, right rear and left rear speakers, and subwoofer

If desired, you can adjust the sound output level of the each speaker even if the output level is already set in "SPEAKER BALANCE ADJUSTMENT" on pages 41 to 42.

Speakers	Control range (dB)	Preset value
FRONT	MIN, -20 to +10	0
CENTER	MIN, -20 to +10	0
RIGHT SURROUND	MIN, -20 to +10	0
LEFT SURROUND	MIN, -20 to +10	0
SUBWOOFER	MIN, -20 to 0	0

NOTES

- Output level of the front effect speakers cannot be adjusted when the program DOLBY PRO LOGIC (DOLBY DIGITAL) is selected.
- Output level of the center speaker cannot be adjusted when the program STADIUM, DISCO, ROCK CONCERT, JAZZ CLUB, CHURCH or CONCERT HALL is selected, and the input signal is analog, PCM audio or encoded with the Dolby Digital (AC-3) in 2-channels.
- Once the output level is adjusted, the level value will be the same in all the digital sound field programs.

NOTE

The values of the delay time and each speaker level you set the last time will remain memorized even when the power of this unit is off.

However, if the power cord is kept disconnected for more than one week, these values will be automatically changed back to the original factory settings.

SETTING THE SLEEP TIMER

If you use the SLEEP timer of this unit, you can make this unit turn off automatically. When you are going to sleep while enjoying a broadcast or other desired input source, this timer function is helpful.

NOTES

- The SLEEP timer can be controlled only with the remote control unit.
- The components on which the SLEEP timer is effective are the sources connected to the SWITCHED AC OUTLET(S) on the rear panel of this unit.

To set the SLEEP time

1. Press the SLEEP key.

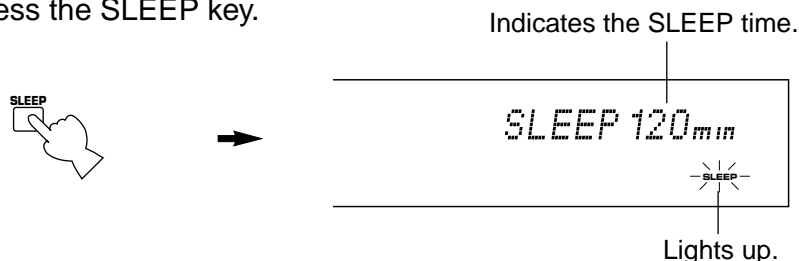

Press once or more to select the desired SLEEP time. Whenever the SLEEP key is pressed, the SLEEP time will change as follows.

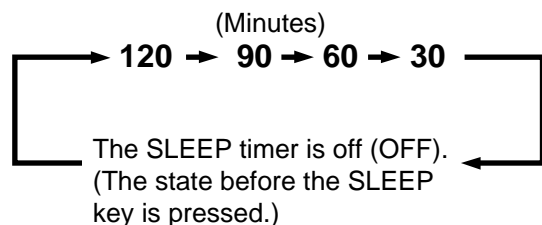

After a while, the display returns to the indication before the SLEEP timer is set.

2. The unit will be turned off automatically at the selected SLEEP time.

To cancel the selected SLEEP time

Press the SLEEP key once or more so that "SLEEP OFF" appears on the display panel. (It will soon disappear and the "SLEEP" indicator will go off from the display panel.)



NOTE

The SLEEP timer setting can also be canceled by turning off the power with the POWER switch or disconnecting the power plug of this unit from the AC outlet.

REMOTE CONTROL UNIT

BASIC OPERATIONS (When the lid is open)

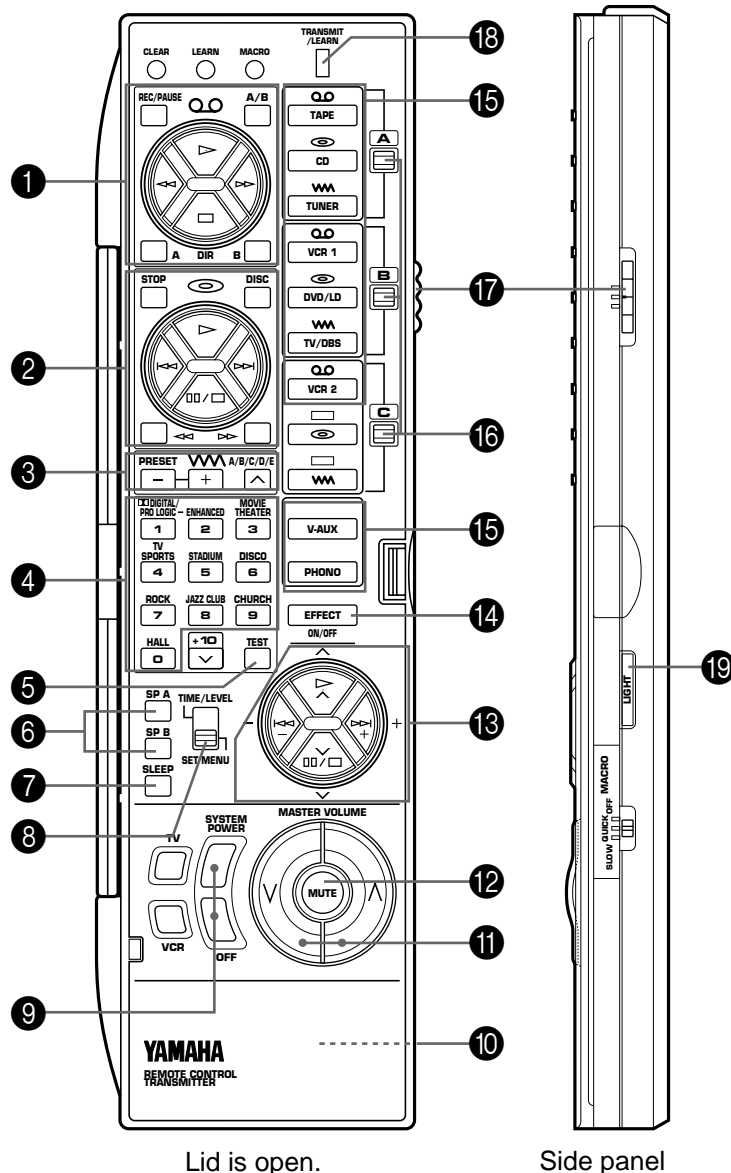

Lid is open.

Side panel

The remote control unit provided with this unit is designed to control all the most commonly used functions of this unit. If the CD player, tape deck, LD player etc. connected to this unit are YAMAHA components designed for remote control compatibility, then this remote control unit will also control various functions of each component.

* For basic operations, use the remote control unit with the lid open.

NAMES OF KEYS AND THEIR FUNCTIONS

1 Tape deck keys

Controls tape deck.

(The A/B/C switch (17) should be set to the "A" position.)

* DIR A, B and A/B are applicable only to double cassette tape deck.

* For a single cassette deck with automatic reverse function, pressing DIR A will reverse the direction of tape running.

2 CD/LD player keys

Controls compact disc player or LD player.

(To control compact disc player, set the A/B/C switch (17) to the "A" position. To control LD player, set the A/B/C switch (17) to the "C" position.)

* DISC is applicable only to compact disc changer.

* STOP is applicable only to LD player.

3 Tuner keys

Controls tuner.

(The A/B/C switch (17) should be set to the "A" position.)

+: Selects higher preset station number.

-: Selects lower preset station number.

A/B/C/D/E: Selects the group (A – E) of preset station numbers.

4 DSP program selector keys

Selects a DSP program when the built-in digital sound field processor (including the Dolby Pro Logic Surround Decoder or the Dolby Digital (AC-3) Decoder) is on.

5 TEST key

Used when you make speaker balance adjustment to maximize the performance of your audio/video system including this unit. (For details, refer to page 41–42.)

6 SP A and SP B keys

Select the main speakers A or B (or both A and B) you will use by pressing the corresponding key “SP A” or “SP B” (or both keys) so that “SPEAKERS A” or “SPEAKERS B” (or both of them) lights up on the display panel. To cancel selected speakers, press the corresponding key so that the corresponding indicator goes off from the display panel.

7 SLEEP timer key

This key is used to turn the built-in SLEEP timer on and off, and to set the SLEEP time. (See page 61 for details.)

8 TIME/LEVEL-SET MENU switch

Set to the TIME/LEVEL position when you will make an adjustment on delay time, center speaker output level, rear speaker output level, front effect speaker level or subwoofer level. Set to the SET MENU position when you will make an adjustment or setting change on a function in the SET MENU mode.

9 SYSTEM POWER and OFF keys

(U.S.A. and Canada models)

Pressing the SYSTEM POWER key turns the power of this unit on and pressing the OFF key turns the power off.

(Except U.S.A. and Canada models)

While the power is on, pressing the OFF key switches the unit from the power-on mode to the standby mode and pressing the SYSTEM POWER key switches the unit from the standby mode to the power-on mode. (In the standby mode, the standby indicator on the front panel is illuminated.)

10 RESET button

This button is inside the battery compartment.

Press this button to “reset” the internal microcomputer which controls remote control operations. Microcomputer “reset” is necessary when the remote control freezes.

* Pressing the RESET button will not erase learned functions.

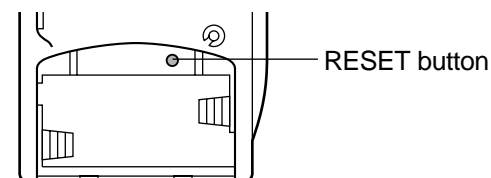
**11** MASTER VOLUME ^ (up) and v (down) keys

Turns the volume level up and down.

12 MUTE key

When pressed, this key mutes the volume level. To resume the original volume level, press this key again.

While muting, the indicator on the VOLUME control flashes continuously.

13 ^/v and -/+ keys

^ (up) and v (down) keys change items (or functions) in the mode selected by the TIME/LEVEL-SET MENU switch. – and + keys make an adjustment or setting change on the item (or function) selected by the ^ or v key.

14 EFFECT ON/OFF key

Switches on/off the digital sound field processor (including the Dolby Pro Logic Surround Decoder or the Dolby Digital (AC-3) Decoder).

15 Input selector keys

Selects input source.

16 A/B/C indicators

The position (A, B or C) selected by the A/B/C switch is shown in red.

17 A/B/C switch

This switch must be used only when the lid of the remote control unit is open. (This switch will not function when the lid is closed.) Normally, set this switch to the “A” position. When controlling a Yamaha LD player by using the CD/LD player keys (**2**), set this switch to the “C” position.

18 TRANSMIT/LEARN indicator

Lights up when the remote control unit is transmitting infrared signals (when a command key is pressed).

19 LIGHT key

If this key is pressed, some of the keys on the remote control unit light up for about 5 seconds. If this key is pressed while those keys are lighting up, they stop lighting.

NOTE

When using the keys to control Yamaha components, identify them with your component's keys. If these keys are identical, their functions will be the same. For each key function, refer to the corresponding instruction in your component's manual.

LEARNING NEW CONTROL FUNCTIONS (When the lid is open)

This is a learning remote control unit. The shaded keys in the illustration shown right can be programmed to “learn” control functions from other remote control units. By learning key-functions from other remote control unit, this unit can then be used in place of one or more other remote control units, thus making operation of your various audio and video components more convenient. Some of the “learning-capable” keys are originally empty and others have already been preset with functions to control this unit and other Yamaha components. You can store new functions to them (in place of preset functions) as desired.

- * See pages 73 to 74 for the learning method.
- * See pages 76 to 77 for clearing a learned function (or all learned functions).

NOTE

If the memory capacity of the remote control unit becomes full, no further learning is possible even if some learning-capable keys are not occupied with new functions. If, for example, you store only Yamaha codes into this remote control unit, up to about 50 functions can be stored. Store new functions to the learnable-capable keys which are useful for you.

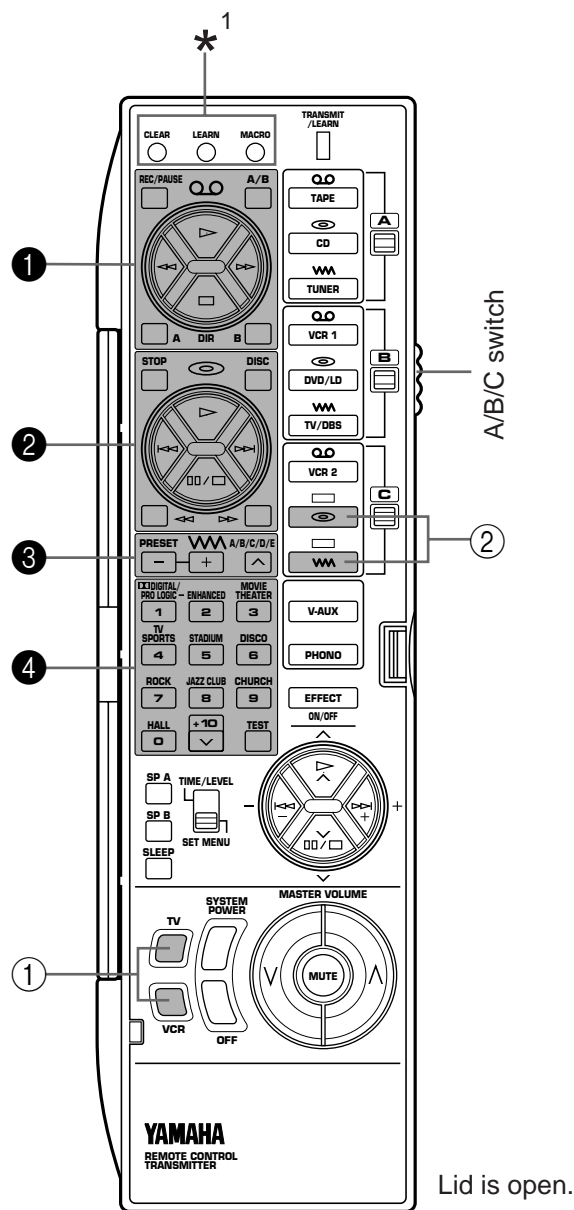

Lid is open.

Keys which can have three functions (①, ②, ③, ④)

In the “Learning-capable” keys, the keys of groups numbered ①–④ in the illustration at left can have three functions. This is because they have three memory areas (A, B and C). (One function per area.) You can store new functions into the area B and C, and use three functions on a key by switching the memory areas with the A/B/C switch. (Area A cannot learn a new function.)

To use these keys:

1. Before using a key, select the area A, B or C of the key on which the function you want to use is stored by using the A/B/C switch.
2. Press the key.

The original factory settings of these keys are as follows.

	The position of A/B/C switch		
	A	B	C
①	Preset with functions for controlling a Yamaha tape deck.	Empty	Empty
②	Preset with functions for controlling a Yamaha CD player. (STOP is empty.)	Empty	Preset with functions for controlling a Yamaha LD player. (DISC is empty.)
③	Preset with functions for controlling the built-in tuner.	Empty	Empty
④	Preset as the DSP program selector keys (1–9, 0) and the TEST key. (+10 is empty.)	Preset as the DSP program selector keys (1–9, 0) and the TEST key. (+10 is empty.)	Preset as the DSP program selector keys (1–9, 0) and the TEST key. (+10 is empty.)

NOTE

The area A of any key cannot learn a new function. To store a new function to a key, store it into the area B or C.

*¹: These buttons are used for learning a new function or clearing a learned function (or all learned functions). See pages 73 to 77 for details.

Empty keys (①, ②)

These are empty keys. Each key can learn a function from another remote control unit.

For example, the TV key is useful for storing the function of your TV's power switch, and the VCR key can be used for your VCR's power switch.

NOTE

If a key which has a preset function learns a new function, the preset function will not be deleted, but disabled. When the learned function is cleared, the preset function is restored. (For information on clearing a learned function, refer to pages 76 to 77.)

About the marks shown on the remote control unit

The marks on the remote control unit signify functions of keys, input sources, etc.

Examples)

- Ⓛ (tape): Shows tape deck, VCR, etc.
- Ⓧ (disc): Shows CD player, LD player, etc.
- Ⓜ (radio wave): Shows tuner, TV/BS tuner, etc.

These marks are helpful for storing new functions.

Examples)

- The area B of keys ① is suitable for storing functions to control your VCR.
- The area B of keys ③ is suitable for storing functions to control your TV/BS tuner.

About the lighting of keys

When you press an input selector key, it lights up for about 3 seconds.

When an input selector key in the group of selected memory area (A, B or C) is pressed, the mark of key group (①—③) which is the same as the mark of the selected input selector key lights up for about 3 seconds.

Example)

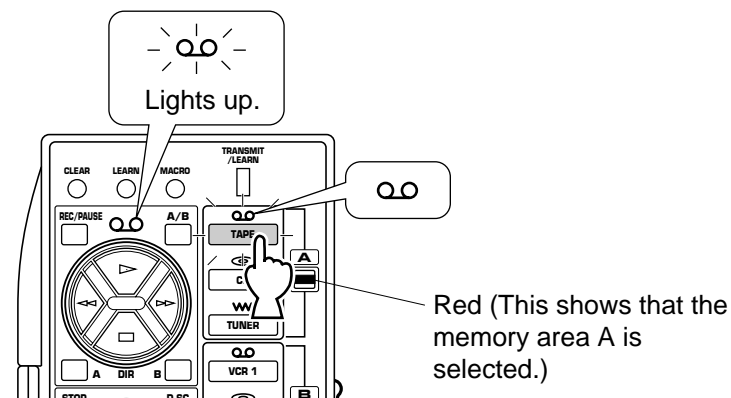

Conversely, when a key of group ①—③ is pressed, its mark and the input selector key with the same mark in the group of the selected memory area light up for about 3 seconds.

This feature may be helpful for you if you store functions for controlling an input source to a group of keys whose mark lights up when the corresponding input selector key is pressed.

USING OPERATION CONTROL KEYS (When the lid is closed)

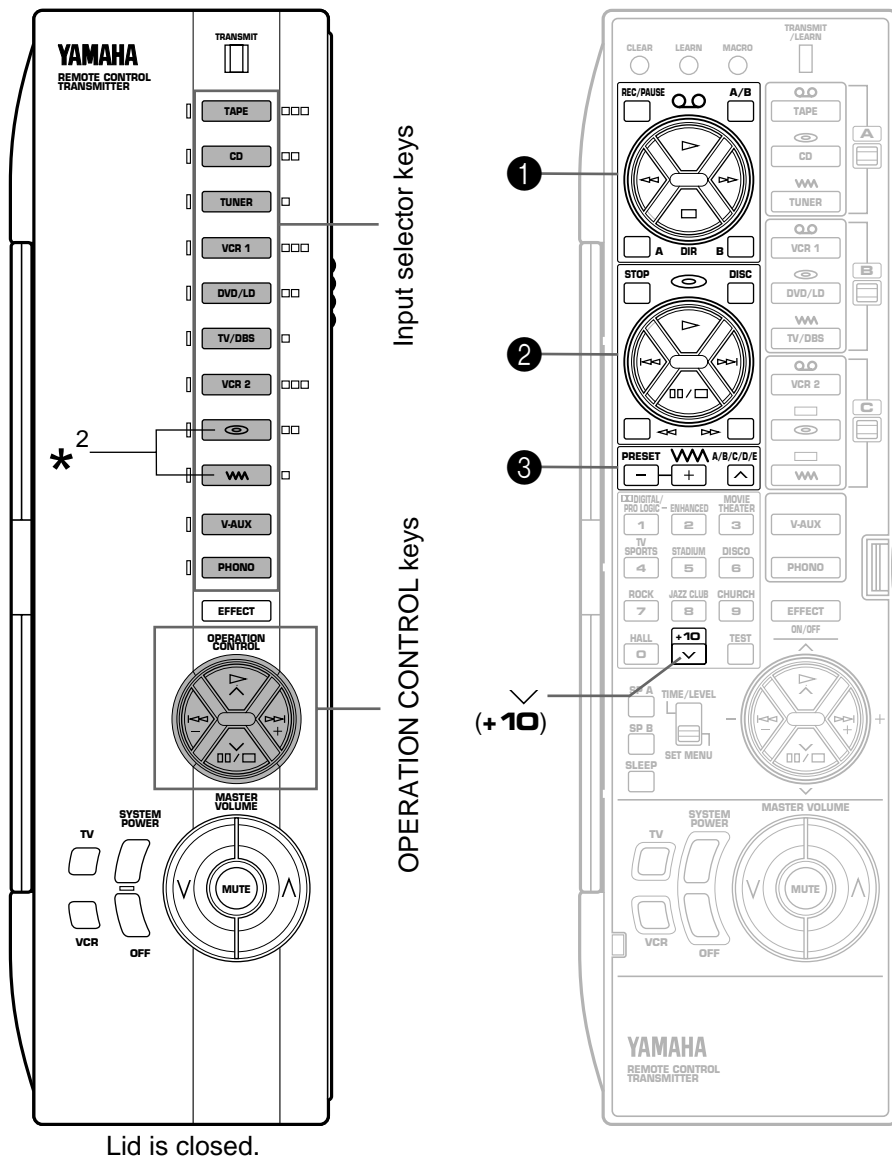

Lid is closed.

When the lid of the remote control unit is closed, you can easily operate Yamaha components including learned functions by using the OPERATION CONTROL keys.

When the lid is closed, the OPERATION CONTROL keys substitute for the keys of group numbered ①, ② or ③ and the √ (+10) key on the left illustration. To use these keys, you do not have to switch the A/B/C switch. The functions which the OPERATION CONTROL keys carry out are determined by which input selector key was pressed before you use the OPERATION CONTROL keys.









NOTE

When the lid is closed, the EFFECT, MASTER VOLUME, MUTE, TV and VCR keys will function in the same way as when the lid is open.

* If the MACRO switch on the side of the remote control unit is set to "OFF", when the lid is closed, the SYSTEM POWER and OFF keys also will function in the same way as when the lid is open.

*²: These keys are originally empty. If these keys have learned functions, pressing them executes those learned functions.

See the table below for a combination of an input selector key and key functions which the OPERATION CONTROL keys carry out. (Also, refer to the table on page 65.)

Selected input selector	Key functions which the OPERATION CONTROL keys carry out
	Functions in area A of keys ❶ (except REC/PAUSE, A/B, DIR A and B)
	Functions in area A of keys ❷ (except STOP, DISC, <<< and >>>)
	Functions in area A of keys ❸ and √ (+10)
	Functions in area B of keys ❶ (except REC/PAUSE, A/B, DIR A and B)
	Functions in area B of keys ❷ (except STOP, DISC, <<< and >>>)
	Functions in area B of keys ❸ and √ (+10)
	Functions in area C of keys ❶ (except REC/PAUSE, A/B, DIR A and B)
	Functions in area C of keys ❷ (except STOP, DISC, <<< and >>>)
	Functions in area C of keys ❸ and √ (+10)

Pressing the “V-AUX” or “PHONO” input selector key has no effect on the OPERATION CONTROL keys.

Examples of operations controlled by using the OPERATION CONTROL keys

To operate a Yamaha CD player

1. Press the “CD” input selector key.
2. Use the OPERATION CONTROL keys. (They carry out the functions in area A of keys ❷.)

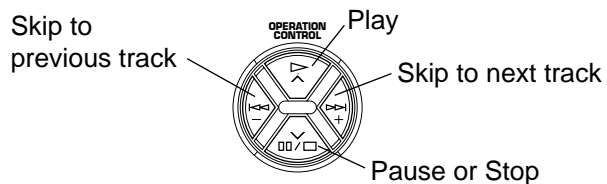

To operate your VCR

1. Press the “VCR” input selector key.
2. Use the OPERATION CONTROL keys. (They carry out the functions in area B of keys ❶. This area is originally preset with no function. You must store the functions related to controlling the VCR in area B of keys ❶ beforehand.)

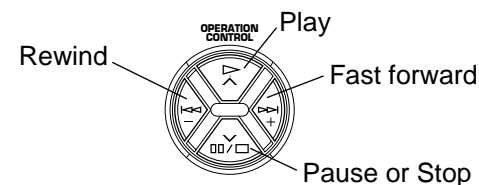

NOTES

- If the OPERATION CONTROL keys substitute for keys which has no function (empty), no command is carried out. According to your plan, store functions from other remote control units into an empty area of those keys. (Refer to pages 73 to 74 for the learning method.)
- While playing an audio/video unit, if you want to operate another unit by using the remote control unit (for example, if you want to rewind a tape on your VCR while listening to a CD), you should open the lid of the remote control unit and use the A/B/C switch and the corresponding keys. (If you press an input selector key with the lid closed to change the functions of the OPERATION CONTROL keys to the functions for controlling a VCR, the input of currently playing CD source is canceled.)

About the lighting of keys

When an input selector key is pressed, the pressed key and only the available OPERATION CONTROL keys (which substitute for the keys stored with the preset functions or learned functions) light up for about 3 seconds. So you can know what keys are available at a glance.

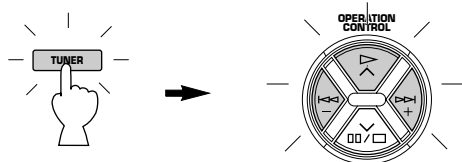

Conversely, when an OPERATION CONTROL key is pressed, all of the available OPERATION CONTROL keys and the currently selected input selector key light up.

MACRO OPERATIONS (When the lid is closed)

“Macro” is a command which defines a sequence of several operations.

The keys shown in the right illustrations (as “preset macro keys”) are also preset with macros, in addition to individual functions. Each macro key is preset so that simply pressing it alone will carry out several functions of other keys on this remote control unit sequentially. (To know what key functions are sequentially carried out by pressing each preset macro key, see the next page.)

Macros can be used only when the lid is closed and the MACRO switch is set to “SLOW” or “QUICK”. (If “OFF” is selected, no macro will function even if the lid is closed.)







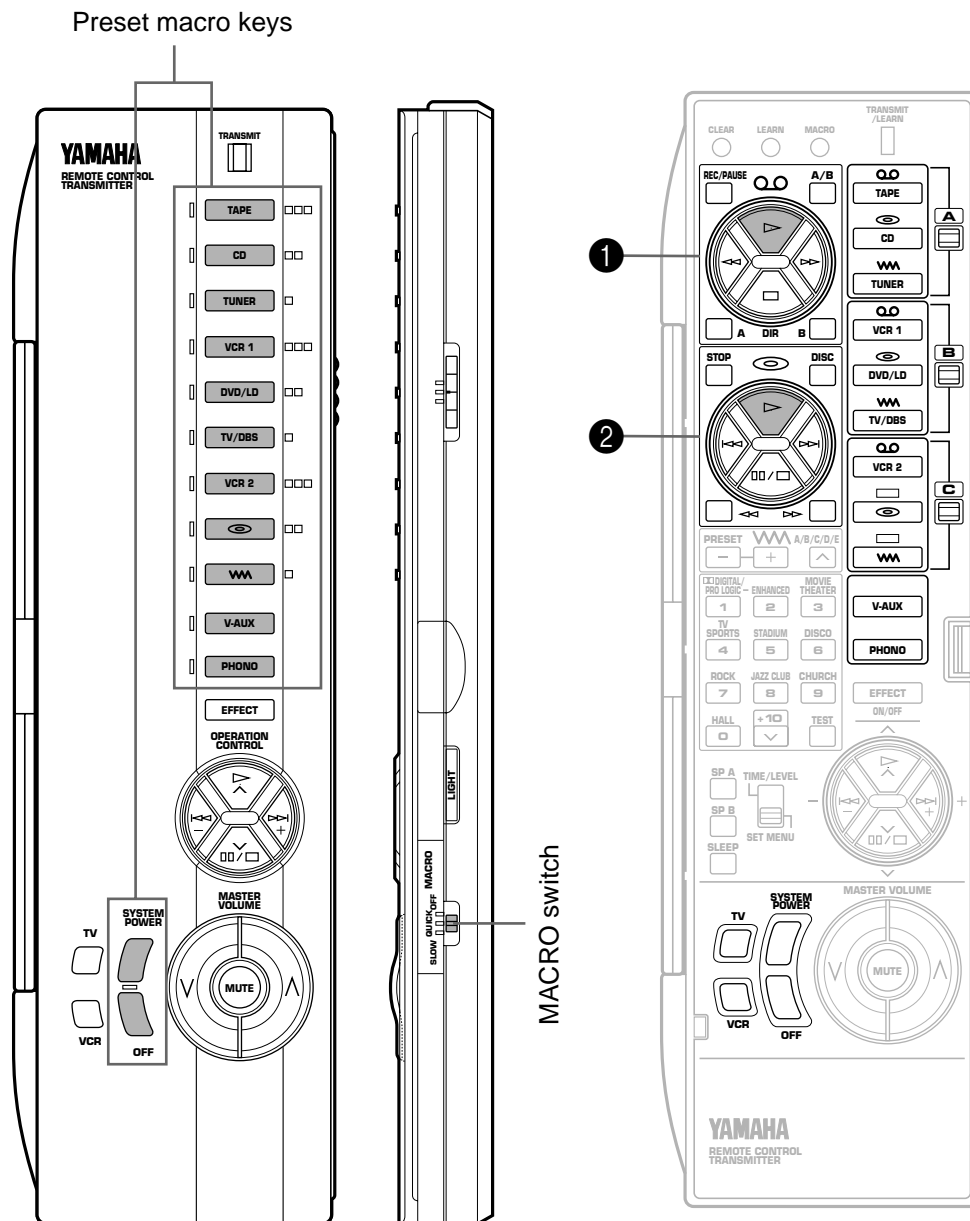





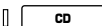

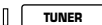

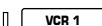

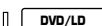

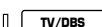

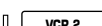
Preset macro keys are originally preset with macros. If you prefer, however, you can change the contents of a macro key by storing a desired series of functions on it. You can store up to seven functions onto a macro key. (See page 75 for the learning method.)

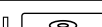

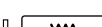

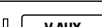

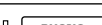
Setting the MACRO switch

- OFF:** In this position, no macro will function even if the lid of remote control unit is closed.
- QUICK:** In this position, when a macro key is pressed, each command is transmitted at 0.5 second intervals.
- SLOW:** In this position, when a macro key is pressed, each command is transmitted at 3 second intervals.



Preset macro keys and the key functions which they carry out sequentially are as follows. (Also, refer to the table on page 65.)

Macro key	Function of the key (and area) which operates when a macro key is pressed		
	1st (Turning the power of this unit on)	2nd (Selecting an input source)	3rd (Playing a source)
 TAPE		 TAPE	“▷” on area A of keys ①
 CD		 CD	“▷” on area A of keys ②
 TUNER		 TUNER	—
 VCR 1		 VCR 1	“▷” on area B of keys ①
 DVD/LD		 DVD/LD	“▷” on area B of keys ②
 TV/DBS		 TV/DBS	—
 VCR 2		 VCR 2	“▷” on area C of keys ①
			“▷” on area C of keys ②
 WMA		 WMA	—
 V-AUX		 V-AUX	—
 PHONO		 PHONO	—

Macro key	Function of the key which operates when a macro key is pressed		
	1st	2nd	3rd
			
		—	—

NOTES

- A key in which no function is stored will carry out no command.
- If it occurs that this unit will not receive the second command because the internal operation of the first command takes a long time, set the MACRO switch to the "SLOW" position, or add no function or repeat the same command between the first command and the next command.
- If you will program the power on/off switching function of TV, VCR, etc. as part of a macro sequence, note that it switches the current mode to the other ("on" to "off", or "off" to "on"). For example, when you press the macro key, if the power of TV, VCR, etc. is already on, the power will be turned off even though you may not want it to do so.
- Once you press a macro key, this unit will not receive the command of another key (even if it is pressed) until this unit finishes carrying out all commands of the macro key. Take notice of this especially when the MACRO switch is in the "SLOW" position.
- Once you press a macro key, you must keep the remote control unit directed at the main unit's remote control sensor until the remote control unit finishes transmitting all command signals of the macro key.
- You can use the OPERATION CONTROL keys also while using the macro functions.

LEARNING A NEW FUNCTION

1 Place this remote control unit and the other remote control unit so that they face each other.

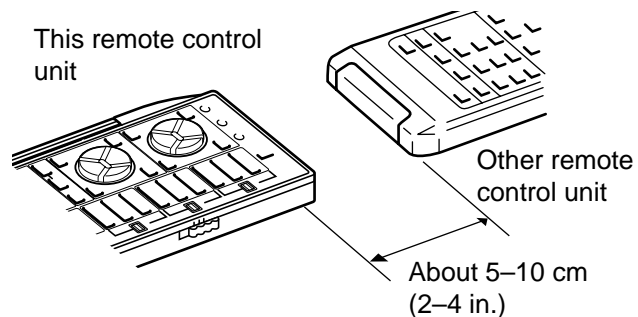

2 Press the LEARN button using the point of a mechanical pencil etc.

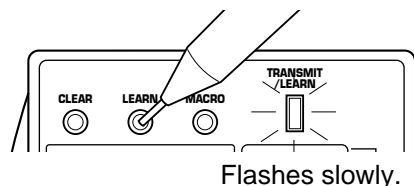

* If there is no operation for about 30 seconds after the LEARN button is pressed, the TRANSMIT/LEARN indicator flashes rapidly and the current mode is canceled. If this occurs, repeat this step.

3 If necessary, select the memory area by using the A/B/C switch on the side panel of the remote control unit.

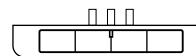

4 Press the key on this remote control unit in which you will store a new function.

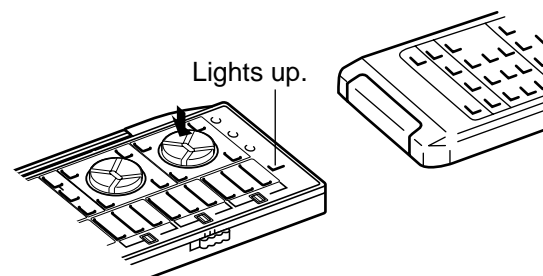

- * If a key which cannot learn another function is pressed, the TRANSMIT/LEARN indicator flashes rapidly and the current mode is canceled. If this occurs, repeat this step.
- * If there is no operation for about 30 seconds after a key is pressed, the TRANSMIT/LEARN indicator flashes rapidly and the mode before you began learning operations is restored. If this occurs, restart from step 2.

5 Press and hold the key (on the other remote control unit) which has the function you want to store.

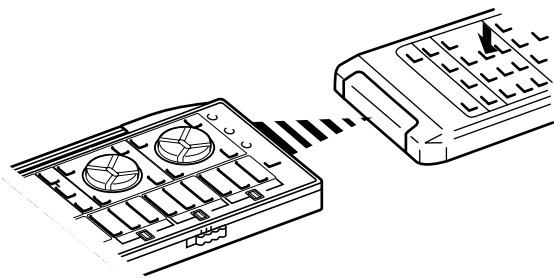

- * When learning is finished, the TRANSMIT/LEARN indicator stops lighting and then begins flashing slowly.
- * If a signal is not successfully received, the TRANSMIT/LEARN indicator flashes rapidly and the mode prior to step 4 is restored. If this occurs, restart from step 4.
- * If memory capacity is full, the TRANSMIT/LEARN indicator flashes rapidly to show you that learning is impossible, and then the mode before you began learning operations is restored.

6 Repeat step 3–5 to store more functions.

7 When you finish the learning operation, press the LEARN button.

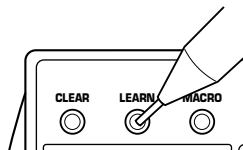

NOTES

- Newly learned functions will replace previously learned functions.
- If there is no more room in the memory area for a function to be learned, the TRANSMIT/LEARN indicator will flash rapidly. In this case, even if some keys are not occupied with functions from other remote control units, no further learning is possible.
- If the lid is closed while learning and about 5 seconds pass, the TRANSMIT/LEARN indicator flashes rapidly and the mode before you began learning operations is restored. If this occurs, restart from step 2. However, if the lid is opened within 5 seconds, the mode before the lid was closed is restored.
- There may occasionally be instances in which, due to the signal-coding and modulation employed by the other remote control unit, this remote control unit will not be able to “learn” its signals.

MAKING A NEW MACRO

A new macro can be programmed onto any preset macro key in place of preset functions. (See page 70 to know what keys are preset macro keys.) You can make as many as 13 new macro keys. A macro key can learn as many as seven functions of other keys.

NOTE

If you store a continuous command such as lowering of volume level, it will become a short command when it is carried out as a part of macro.

- 1 Press the MACRO button using the point of a mechanical pencil etc.

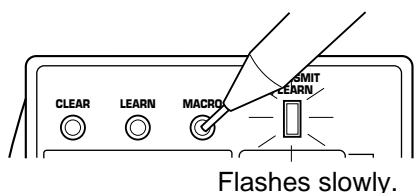

- * If there is no operation for about 30 seconds after the MACRO button is pressed, the TRANSMIT/LEARN indicator flashes rapidly and the mode before you pressed the MACRO button is restored. If this occurs, press the MACRO button again.

- 2 Press a preset macro key on which you want to make a new macro.

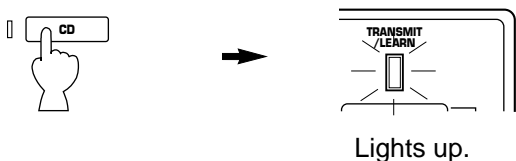

- * If a key other than a preset macro key is pressed, the TRANSMIT/LEARN indicator flashes rapidly and the current mode is canceled. If this occurs, repeat this step.

- 3 Press a key whose function you want to store as the first function of the new macro.

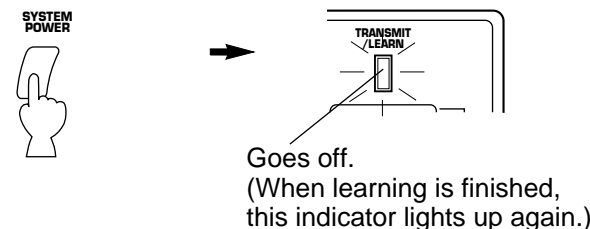

- * If a key whose function cannot be stored as a command of macro is pressed, the TRANSMIT/LEARN indicator flashes rapidly and the current mode is canceled. If this occurs, repeat this step.

- * If about 30 seconds pass before a key is pressed, the TRANSMIT/LEARN indicator flashes rapidly and the mode before you began learning operations is restored. If this occurs, restart from step 1.

- 4 Repeat step 3 to store the second, the third and more functions. You can store up to seven key functions in series as a macro.

- * If the seventh key function has been learned, the TRANSMIT/LEARN indicator flashes rapidly and the mode before you began learning operations is restored. (This shows that the key has completed learning a series of functions as a macro.) If this occurs, you do not have to follow the next step.

- 5 When you finish learning, press the MACRO button.

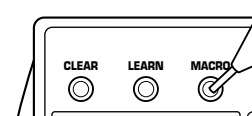

It is recommended to write down new key functions you stored on the provided user function stickers and paste them on the reverse side of the remote control unit or the reverse side of the remote control unit's lid.

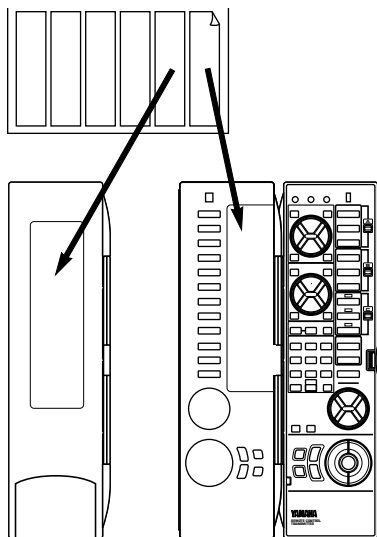

Memory back-up

All of the learned functions will be retained while you replace the batteries. However, if no batteries are installed for a few hours, the learned functions will be erased and will have to be learned again.

CLEARING LEARNED FUNCTIONS

To Clear a Learned Function

- 1 To clear a learned key function, press the LEARN button using the point of a mechanical pencil, etc.
To clear a macro you made, press the MACRO button.

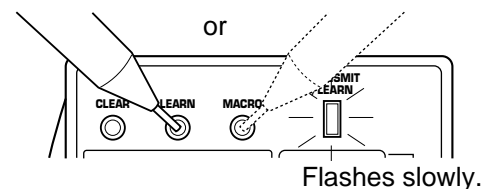

- 2 Press and hold the CLEAR button using the point of a mechanical pencil, etc.

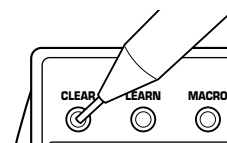

- 3 Holding the CLEAR button pressed, press and hold the key whose function you want to clear until the indicator flashes 3 times.

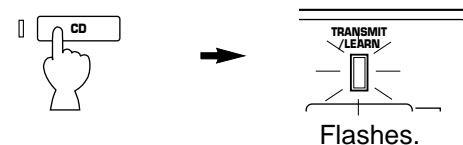

To clear two or more functions sequentially, do not release the CLEAR button pressed, and repeat this step.

NOTE

If you clear a learned function of a key, the originally preset function of the key is restored (except the keys which are originally preset with no function.)

To Clear All Learned Functions

1 Select the kind of key functions all of which you want to clear by using the MACRO switch on the side panel of the remote control unit.

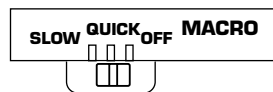

OFF: Select this position if you want to clear all of the learned functions except macros.

QUICK: Select this position if you want to clear all of the macros you made only.

SLOW: Select this position if you want to clear all of the learned functions including macros.

2 Press the CLEAR button using the point of a mechanical pencil, etc.

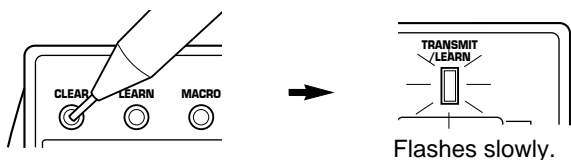

3 Press and hold the CLEAR button again. While holding the CLEAR button pressed, press and hold the MASTER VOLUME \wedge and \vee keys simultaneously until the indicator flashes 7 times.

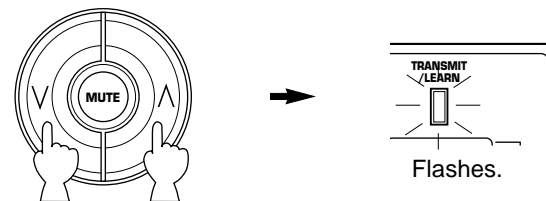

Flashes.

* If one of the following operation is made after you press the CLEAR button, the TRANSMIT/LEARN indicator flashes rapidly and the current mode is canceled. If this occurs, press the CLEAR button again.

- MACRO switch is switched to another position.
- Another key is pressed.
- There is no operation for about 30 seconds.

TROUBLESHOOTING

General

PROBLEM	POSSIBLE CAUSE	WHAT TO DO
Power does not come on.	AC cord not properly plugged in.	Carefully plug AC plug into outlet.
The unit turns off suddenly soon after the power is turned on.	The IMPEDANCE SELECTOR switch on the rear panel is not set to the upper or the lower end exactly.	Set the switch to the upper or the lower end exactly.
Hum.	Bad cable connection.	Firmly plug in all connection cables.
No sound.	Bad or incorrect input connection. Incorrect input source selection. Digital signals other than PCM audio or the Dolby Digital (AC-3) encoded signals which this unit cannot reproduce are input to this unit by playing a CD-ROM etc.	Check connections. Select the appropriate input source with the input selector buttons. Play a source whose signals this unit can reproduce.
No sound from the effect speakers.	The EFFECT switch is set off. A Dolby Surround decoding program is being used with material not encoded with Dolby Surround.	Press the EFFECT switch to turn it on. Use a different sound field program.
No sound from the front effect speakers.	The FRONT MIX switch is set to "ON". The sound field program No. 1 "DOLBY PRO LOGIC (DOLBY DIGITAL)" is selected.	Set the FRONT MIX switch to "OFF". Select another program.
No sound from the center speaker.	The CENTER SPEAKERS mode is in "PHNTM". One of the sound field programs No. 5 to No. 10 is selected when the input signal of source is 2-channel stereo (analog/PCM). The input signals of source encoded with the Dolby Digital (AC-3) do not have center channel signals.	Select the appropriate mode. Select another program. Refer to the instructions for the source currently played.
Poor bass reproduction.	The LFE/BASS OUT mode is in the SWFR or BOTH position, though your system does not include a subwoofer. Output mode selection for each channel (MAIN, CENTER or REAR) is improper.	Select the MAIN position. Make output mode selections suitable for your speaker system.
The sound suddenly goes off.	The protection circuit has activated because of short circuit etc.	Turning the unit off and then on will reset the protection circuit.
The volume level cannot be increased, or sound is distorted.	The power to the component connected to the REC OUT jacks of this unit is off.	Turn the power to the component on.
The sound field cannot be recorded.	It is not possible to record the sound field on a tape deck connected to this unit's TAPE REC OUT jacks.	

PROBLEM	POSSIBLE CAUSE	WHAT TO DO
This unit will not operate properly.	The internal microcomputer has been frozen by an external electric shock (lightning, excessive static electricity, etc.) or power supply with low voltage.	Unplug the AC power cord from the wall AC outlet, and then plug in again after about one minute.
A source cannot be recorded by a tape deck or VCR connected to this unit.	The source unit is connected to this unit between digital jacks only.	Make additional connection between analog jacks.
Noise from nearby TV or tuner.	This unit is too close to the affected equipment.	Move the unit further away from the affected equipment.
The sound is degraded when listening with the headphones connected to the compact disc player or cassette deck that are connected with this unit.	The power to this unit is off.	Turn the power to this unit on.

Remote control unit

PROBLEM	POSSIBLE CAUSE	WHAT TO DO
The remote control unit does not work.	The batteries of this remote control unit are weak.	Replace the batteries with new ones and press the RESET button on the remote control unit.
	The internal microcomputer "freezes".	Press the RESET button on the remote control unit.
The remote control unit does not function properly.	Wrong distance or angle.	The remote control unit will function from a maximum range of 6 meters, no more than 30 degrees off-axis from the front panel.
	Direct sunlight or lighting (of an inverter type of fluorescent lamp etc.) is striking the remotecontrol sensor of the main unit.	Change position of the main unit.
	The internal microcomputer "freezes".	Press the RESET button on the remote control unit.
Learning cannot be made successfully. (The TRANSMIT/LEARN indicator does not light up or flash.)	The batteries of this remote control unit and/or the other remote control unit are weak.	Replace the batteries (and press the RESET button for this remote control unit).
	The distance between the two remote control units is too long or too short.	Place the remote control units with the proper distance.
	The signal coding or modulation of the other remote control unit is not compatible with this remote control unit.	Learning is not possible.
	Memory capacity is full.	Further learning is not possible without deleting unnecessary commands.
Continuous functions such as volume are learned, but operate only for a moment before stopping.	The internal microcomputer "freezes".	Press the RESET button on the remote control unit.
	Learning process incomplete.	Be sure to press and hold the function key on the other remote control until the TRANSMIT/LEARN indicator begins flashing slowly.

Tuner

PROBLEM	POSSIBLE CAUSE	WHAT TO DO
FM stereo reception is noisy.	Because of the characteristics of FM stereo broadcasts, this is limited to cases where the transmitter is too far away or the antenna input is poor.	Check the antenna connections. Try using a high quality directional FM antenna. Set the TUNING MODE button to the manual tuning mode.
There is distortion and clear reception cannot be obtained even with a good FM antenna.	There is multipath interference.	Adjust antenna placement to eliminate multipath interference.
A desired FM station cannot be tuned in with the automatic tuning method.	The station is too weak.	Use the manual tuning method. Use a high quality directional FM antenna.
Previously preset stations can no longer be tuned in.	This unit has been unplugged for a long period.	Repeat the presetting procedure.
A desired AM station cannot be tuned in with the automatic tuning method.	Weak signal or loose antenna connections.	Tighten the AM loop antenna connections and rotate it for best reception. Use the manual tuning method.
There are continuous crackling and hissing noises.	Noises will result from lightning, fluorescent lamps, motors, thermostats and other electrical equipment.	Use an outdoor antenna and a ground wire. This will help somewhat but it is difficult to eliminate all noise.
There are buzzing and whining noises (especially in the evening).	A television set is being used nearby.	Relocate this unit away from the TV.

SPECIFICATIONS

AUDIO SECTION

Minimum RMS Output Power Per Channel

Main (20 Hz – 20 kHz 0.02% THD 8Ω)	100W+100W
Center (20 Hz – 20 kHz 0.02% THD 8Ω)	100W
Front Effect (1 kHz 0.05% THD 8Ω).....	25W+25W
Rear (20 Hz – 20 kHz 0.02% THD 8Ω)	100W+100W

Dynamic Power Per Channel

(by IHF Dynamic Headroom Measuring Method)

[U.S.A., Canada and General models]	
MAIN L/R (8Ω/6Ω/4Ω/2Ω)	140W/170W/220W/320W

Maximum Output Power [General model only]

MAIN L/R (1 kHz 10% THD 8Ω)	135W+135W
-----------------------------------	-----------

Dynamic Headroom [U.S.A., Canada and General models]

MAIN L/R (8Ω)	1.46 dB
---------------------	---------

DIN Standard Output Power Per Channel [Europe and U.K. models]

MAIN L/R (1 kHz 0.7% THD 4Ω)	160W
------------------------------------	------

IEC Power [Europe and U.K. models]

MAIN L/R (1 kHz 0.015% THD 8Ω)	115W
--------------------------------------	------

Damping Factor

MAIN L/R (20 Hz – 20 kHz 8Ω)	200
------------------------------------	-----

Input Sensitivity/Impedance (100W/8Ω)

CD/TAPE/DVD-LD/TV-DBS/VCR/VIDEO AUX	150 mV/47 kΩ
PHONO MM	2.5 mV/47 kΩ
MAIN IN	1V/47 kΩ

Maximum Input Signal (1 kHz 0.05% THD, EFFECT ON)

CD/TAPE/DVD-LD/TV-DBS/VCR/VIDEO AUX	2.2V
PHONO MM	110 mV

Output Level/Impedance

REC OUT	150 mV/2.7 kΩ
PRE OUT	
MAIN, CENTER, REAR, FRONT EFFECT	1V/1.2 kΩ
SUBWOOFER (MAIN SPEAKERS: SMALL)	3.4V/1.2 kΩ

Maximum Voltage Output (20 Hz – 20 kHz, 1% THD)

PRE OUT (MAIN L/R).....	3V
-------------------------	----

Headphone Jack Rated Output/Impedance

Output Level (CD Input 150 mV, RL=8Ω).....	0.5V
Impedance	440Ω

Frequency Response (20 Hz – 20 kHz)

CD/TAPE/DVD-LD/TV-DBS/VCR/VIDEO AUX to MAIN L/R SP OUT	
.....	0±0.5 dB

RIAA Equalization Deviation (20 Hz – 20 kHz)

PHONO MM	0±0.5 dB
----------------	----------

Total Harmonic Distortion

PHONO MM to REC OUT, 20 Hz – 20 kHz, 1V	0.01% or less
MAIN IN to SP OUT (MAIN L/R, CENTER), 20 Hz–20 kHz, 50W/8Ω	
.....	0.008% or less
CD/TAPE/DVD-LD/TV-DBS/VCR/VIDEO AUX to SP OUT	
(MAIN L/R, CENTER), 20 Hz – 20 kHz, 50W/8Ω.....	0.015% or less
CD/TAPE/DVD-LD/TV-DBS/VCR/VIDEO AUX to SP OUT	
(REAR L/R), 1 kHz, 50W/8Ω.....	0.3% or less
CD/TAPE/DVD-LD/TV-DBS/VCR/VIDEO AUX to SP OUT	
(FRONT L/R), 1 kHz, 12.5W/8Ω	0.3% or less
DIGITAL IN (DVD/LD) to SP OUT (MAIN L/R, CENTER, REAR L/R),	
20 Hz – 20 kHz, 50W/8Ω	0.03% or less

Signal-to-Noise Ratio (IHF-A Network)

CD/TAPE/DVD-LD/TV-DBS/VCR/VIDEO AUX (Input Shorted 150 mV)	
(EFFECT OFF)	More than 96 dB
PHONO MM (Input Shorted 5 mV) (EFFECT OFF)	More than 86 dB

Residual Noise (IHF-A Network)

MAIN L/R SP OUT	150 μV
-----------------------	--------

Channel Separation (Vol –30 dB)

CD/TAPE/DVD-LD/TV-DBS/VCR/VIDEO AUX Input 5.1 kΩ Shorted	
(EFFECT OFF) 1 kHz/10 kHz	More than 60 dB/45 dB
PHONO MM Input Shorted (EFFECT OFF)	
1 kHz/10 kHz	More than 60 dB/55 dB

Tone Control Characteristics

Bass	
Boost/Cut	±10 dB (50 Hz)
Turnover frequency	350 Hz
Treble	
Boost/Cut	±10 dB (20 kHz)
Turnover frequency	3.5 kHz

BASS EXTENSION (MAIN L/R) +6 dB (50 Hz)

Filter Characteristics (Highcut Filter)

SUBWOOFER (fc = 90 Hz) 24 dB/oct.

VIDEO SECTION

Video Signal Type

[U.S.A. and Canada Models].....NTSC

[Australia and Singapore models] PAL

[General Model] NTSC/PAL

Video Signal Level 1 Vp-p/75Ω

S-Video Signal Level

Y 1 Vp-p/75Ω

C 0.286 Vp-p/75Ω

Maximum Input Level More than 1.5 Vp-p

Signal-to-Noise Ratio 50 dB

Monitor Out Frequency Response 5 Hz – 10 MHz, –3 dB

FM SECTION

Tuning Range

[U.S.A. and Canada models].....87.5 – 107.9 MHz

[Australia, Singapore and General models]87.5 – 108.0 MHz

50 dB Quieting Sensitivity (IHF, 75 ohms)

Mono1.55 μV (15.1 dBf)

Stereo21 μV (37.7 dBf)

Usable Sensitivity

DIN, Mono (S/N 26 dB)

[Australia and Singapore models].....0.9 μV

DIN, Stereo (S/N 46 dB)

[Australia and Singapore models].....24 μV

Image Response Ratio

[U.S.A., Canada and General models].....45 dB

[Australia and Singapore models]80 dB

IF Response Ratio

[U.S.A., Canada and General models]70 dB

[Australia and Singapore models].....80 dB

Spurious Response Ratio.....70 dB

AM Suppression Ratio55 dB

Capture Ratio1.5 dB

Alternate Channel Selectivity

[U.S.A., Canada and General models].....85 dB

Selectivity (two signals, 40 kHz Dev. ±300 kHz)

[Australia and Singapore models]70 dB

Signal-to-Noise Ratio

(IHF) Mono/Stereo

[U.S.A., Canada and General models]80 dB/75 dB

(DIN-Weighted, 40 kHz Dev.) Mono/Stereo

[Australia and Singapore models]75 dB/70 dB

Harmonic Distortion

Mono/Stereo (1 kHz)0.1/0.2%

Stereo Separation (1 kHz)50 dB

Frequency Response (20 Hz – 15 kHz)0 ±1.5 dB

AM SECTION

Tuning Range

[U.S.A., Canada and General models]	530 – 1,710 kHz
[Australia and Singapore models]	531 – 1,611 kHz

Usable Sensitivity100 μ V/m

Selectivity32 dB

Signal-to-Noise Ratio50 dB

Image Response Ratio40 dB

Spurious Response Ratio50 dB

Harmonic Distortion (1 kHz)0.3%

AUDIO SECTION (TUNER)

Output Level/Impedance

FM (100% mod., 1 kHz)	
[U.S.A., Canada and General models]	500 mV/2.2 k-ohms
[Australia and Singapore models]	400 mV/2.2 k-ohms
AM (30% mod., 1 kHz)	150 mV/2.2 k-ohms

GENERAL

Power Supply

U.S.A. and Canada models	AC 120V/60 Hz
Singapore model	AC 230V/50 Hz
Australia model	AC 240V/50 Hz
General model	AC 110/120/220/240V 60/50 Hz

Power Consumption

U.S.A. model	450W
Canada model	500W/640 VA
Australia, Singapore and General models	480W

AC Outlet(s)

3 SWITCHED OUTLETS	
[U.S.A., Canada, Singapore and General models]	100W max. total
1 SWITCHED OUTLET	
[Australia model]	100W max.

Dimensions (W x H x D)

Except General model	435 x 170 x 476.5 mm (17-1/8" x 6-11/16" x 18-3/4")
General model (with side panels)	473 x 170 x 476.5 mm (18-5/8" x 6-11/16" x 18-3/4")
General model (without side panels)	435 x 170 x 476.5 mm (17-1/8" x 6-11/16" x 18-3/4")

Weight

Except General model	20.0 kg (44 lbs. 0 oz.)
General model (with side panels)	22.0 kg (48 lbs. 6 oz.)
General model (without side panels)	20.0 kg (44 lbs. 0 oz.)

* Specifications are subject to change without notice.

YAMAHA ELECTRONICS CORPORATION, USA 6660 ORANGETHORPE AVE., BUENA PARK, CALIF. 90620, U.S.A.
YAMAHA CANADA MUSIC LTD. 135 MILNER AVE., SCARBOROUGH, ONTARIO M1S 3R1, CANADA
YAMAHA ELECTRONIK EUROPA G.m.b.H. SIEMENSSTR. 22-34, 25462 RELINGEN BEI HAMBURG, F.R. OF GERMANY
YAMAHA ELECTRONIQUE FRANCE S.A. RUE AMBROISE CROIZAT BP70 CROISSY-BEAUBOURG 77312 MARNE-LA-VALLEE CEDEX02, FRANCE
YAMAHA ELECTRONICS (UK) LTD. YAMAHA HOUSE, 200 RICKMANSWORTH ROAD WATFORD, HERTS WD1 7JS, ENGLAND
YAMAHA SCANDINAVIA A.B. J A WETTERGRENS GATA 1, BOX 30053, 400 43 VÄSTRA FRÖLUNDA, SWEDEN
YAMAHA MUSIC AUSTRALIA PTY, LTD. 17-33 MARKET ST., SOUTH MELBOURNE, 3205 VIC., AUSTRALIA

YAMAHA CORPORATION

VY77200 Printed in Japan